

401

DGK-401-026
NECKRING HOLDER
(DGK-0625-E2-7)

Neckring holder DGK-401-026

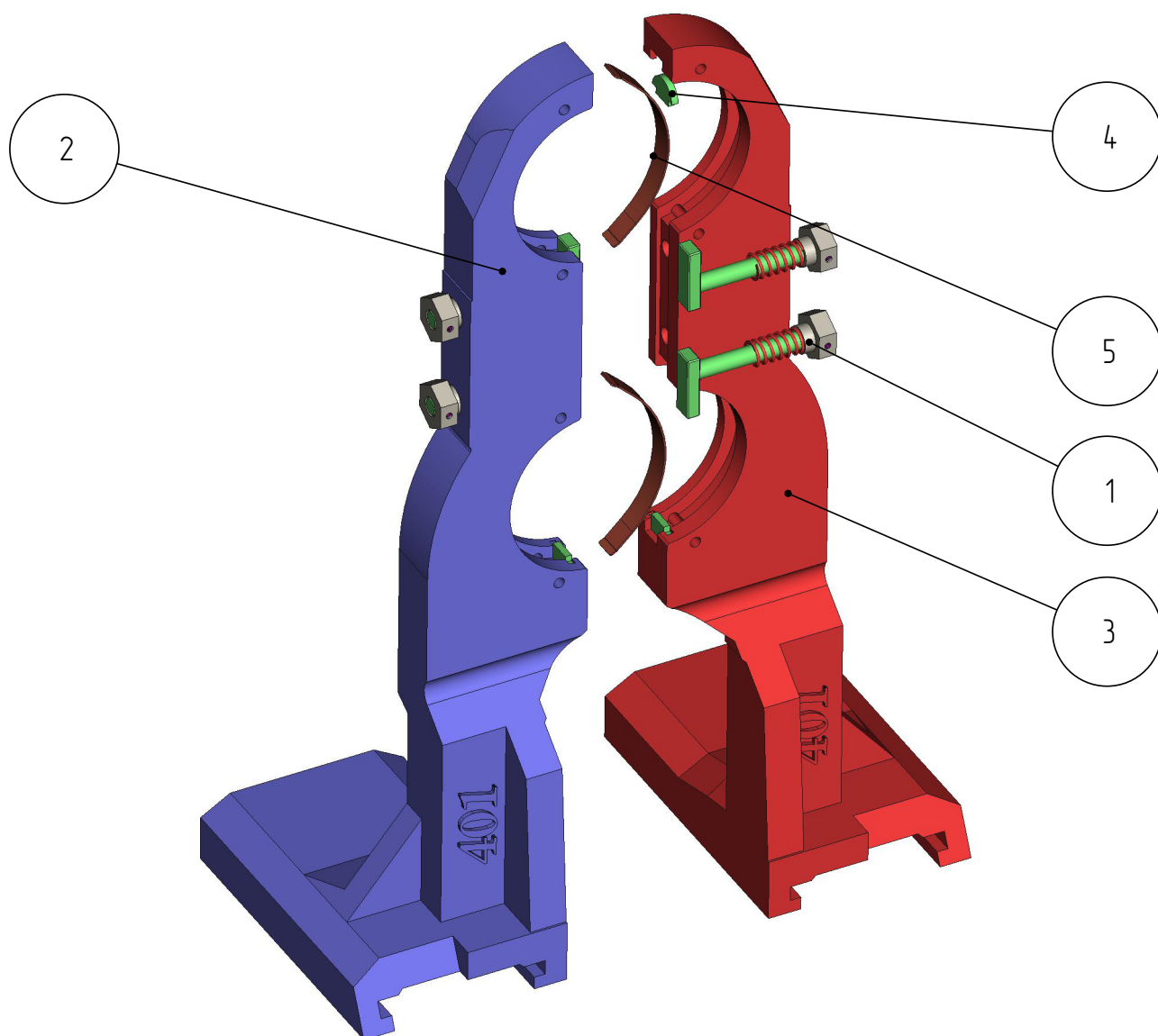

Neckring holder DGK-401-026

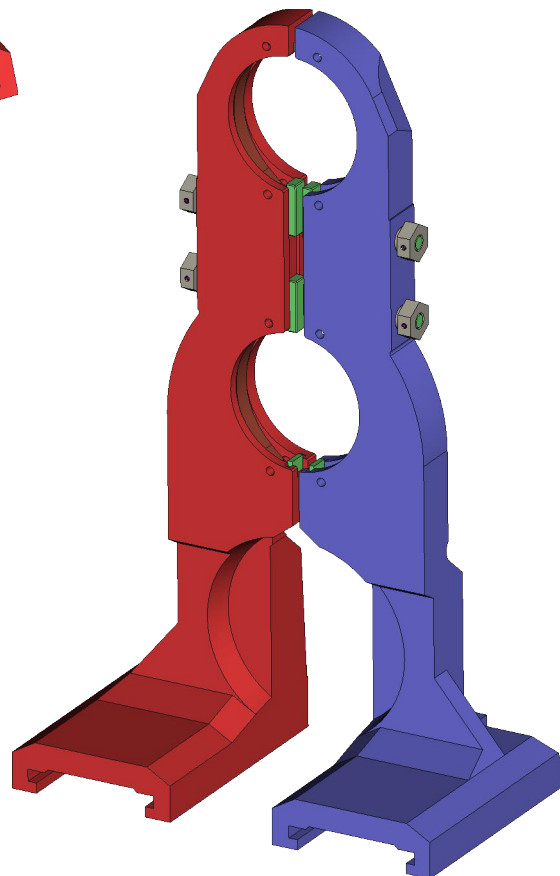
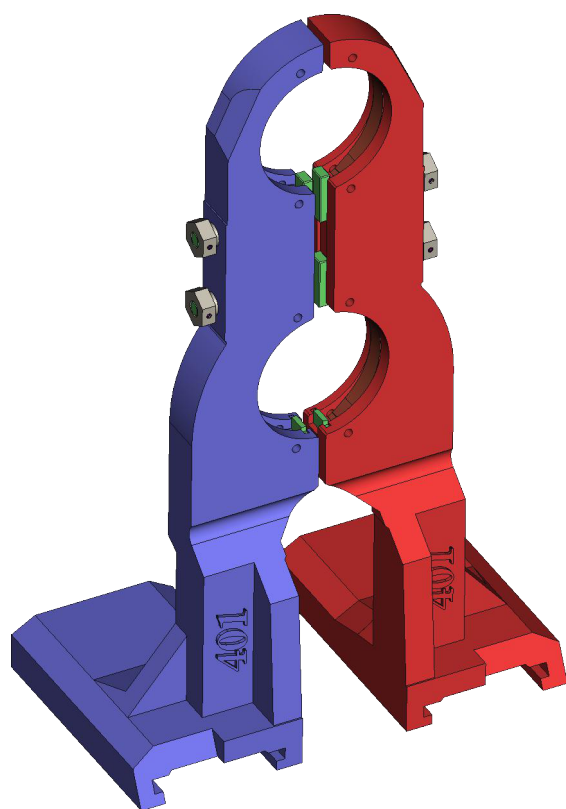

Neckring holder DGK-401-026

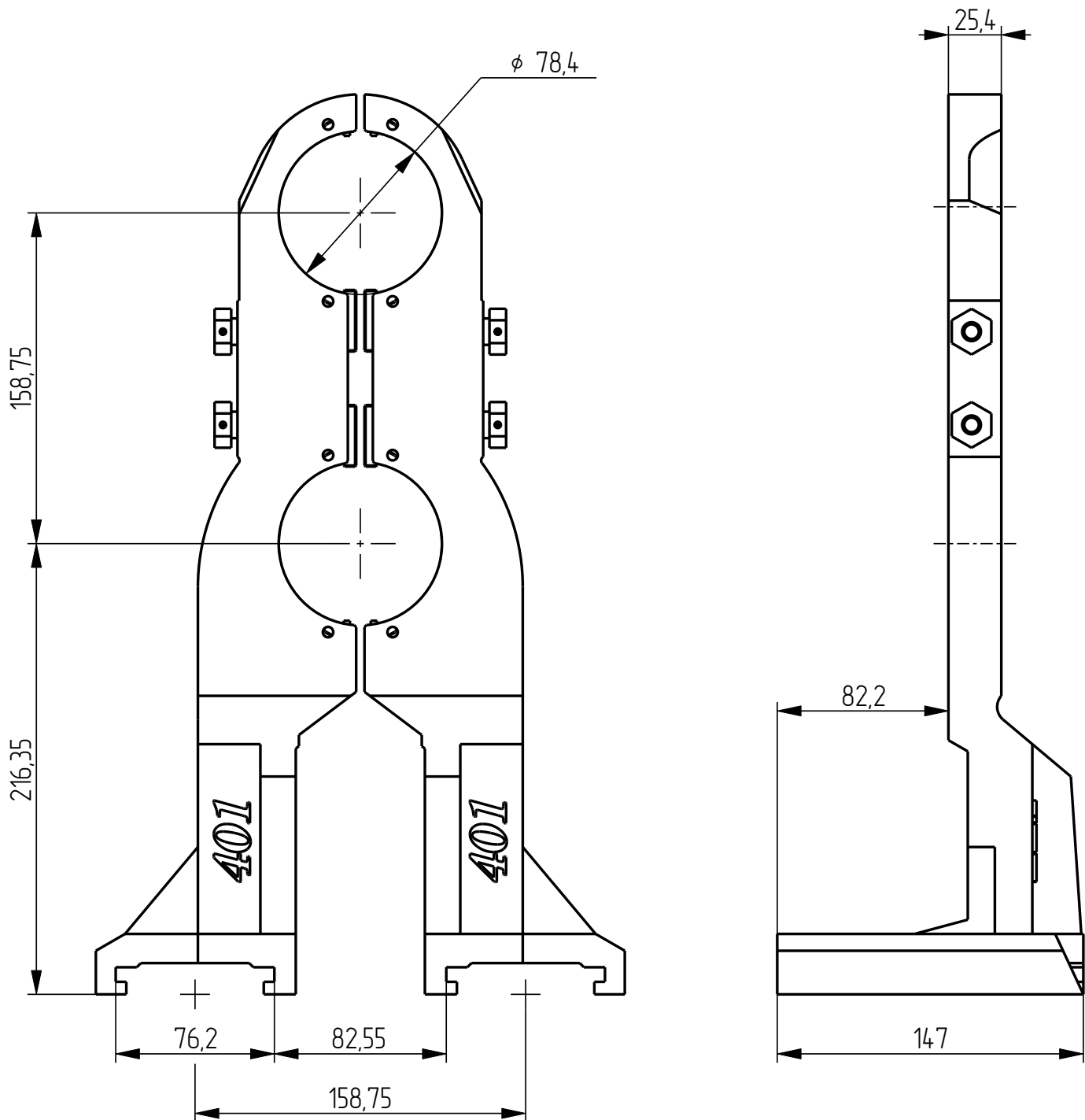

Neckring holder DGK-401-026
Specification

№ pos.	Code	Name	Qty
Assemblies			
1	DGK-401-006-003	Lock	4
Parts			
2	DGK-401-026-001	Neckring holder RH	1
3	DGK-401-026-002	Neckring holder LH	1
4	DGK-401-STANDART-01	Insert	4
5	DGK-401-STANDART-06-L106	Leaf spring	4

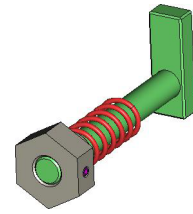
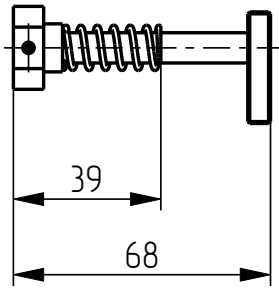
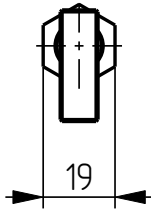

1. Ring
DGK-401-006-003

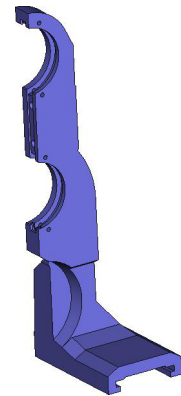
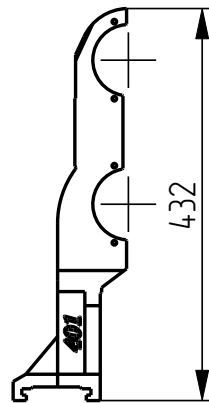
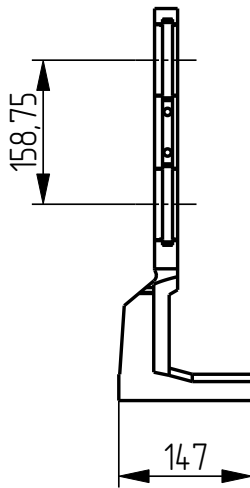

2. Neckring holder RH
DGK-401-026-001

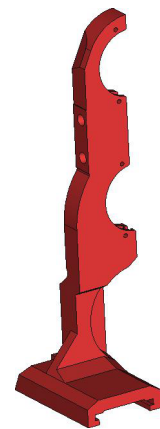
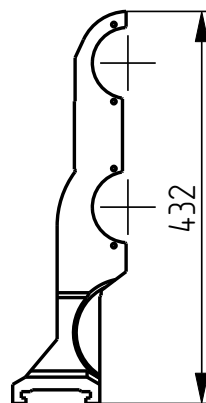
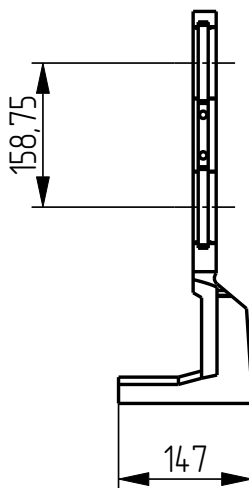

3. Neckring holder LH
DGK-401-026-002

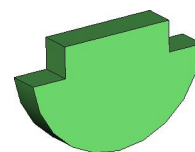
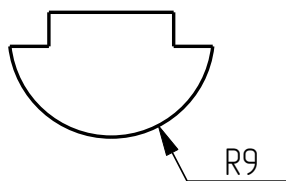
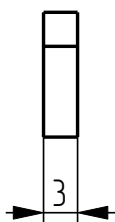

4. Insert
DGK-401-STANDART-01

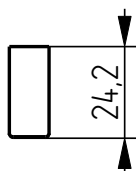
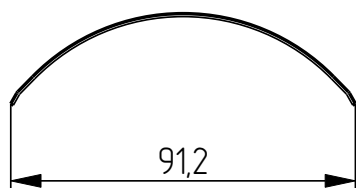

5. Leaf spring
DGK-401-STANDART-06-L106