

401

МХ-401-001
МЕХАНИЗМ ХВАТКА
(450.0145.00.000)

Механизм хватки

МХ-401-001

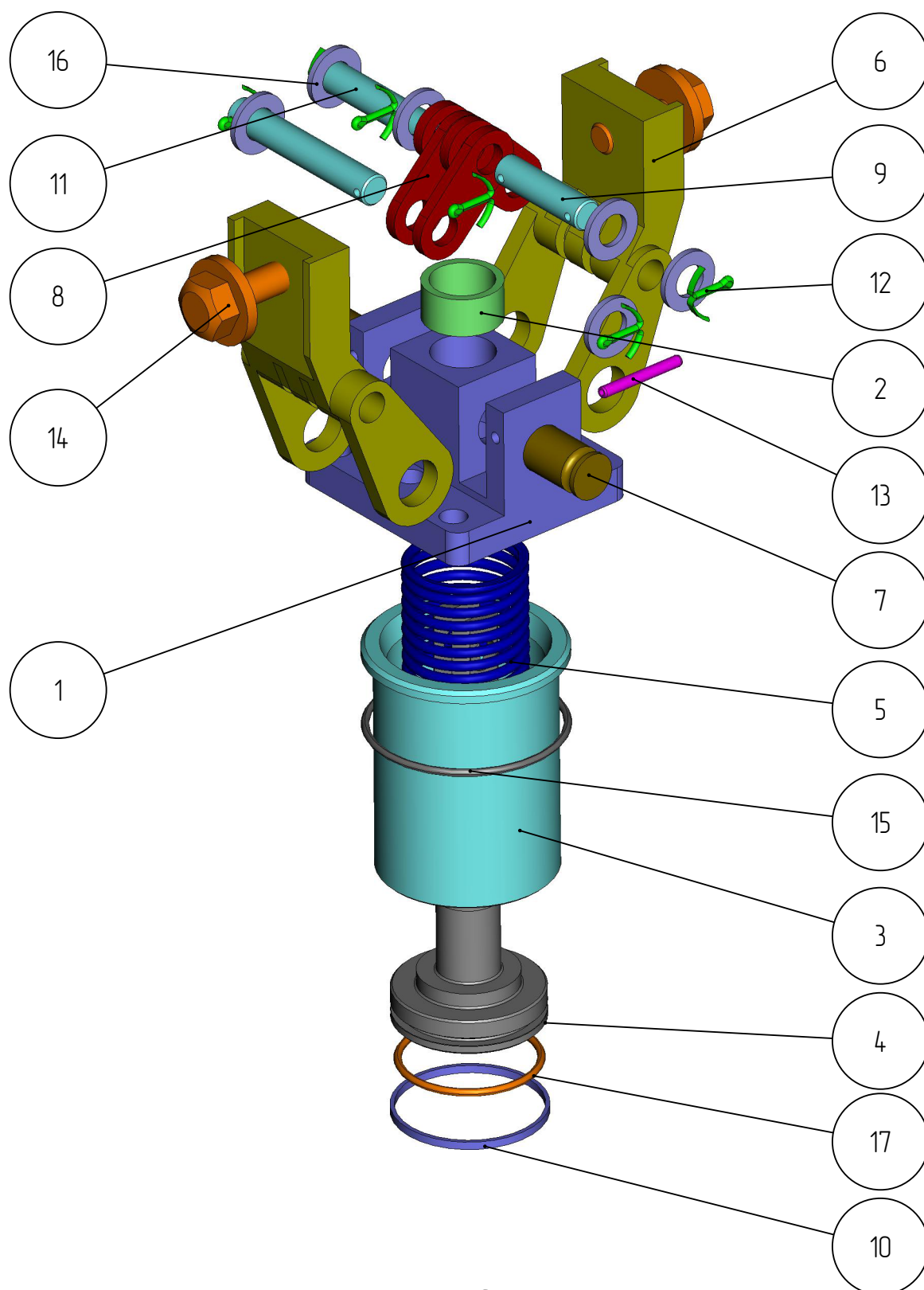

Механизм хватки
МХ-401-001

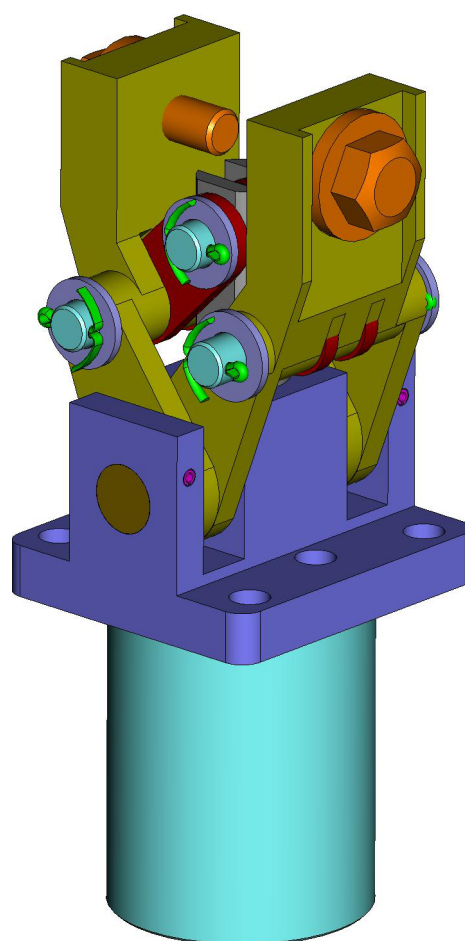
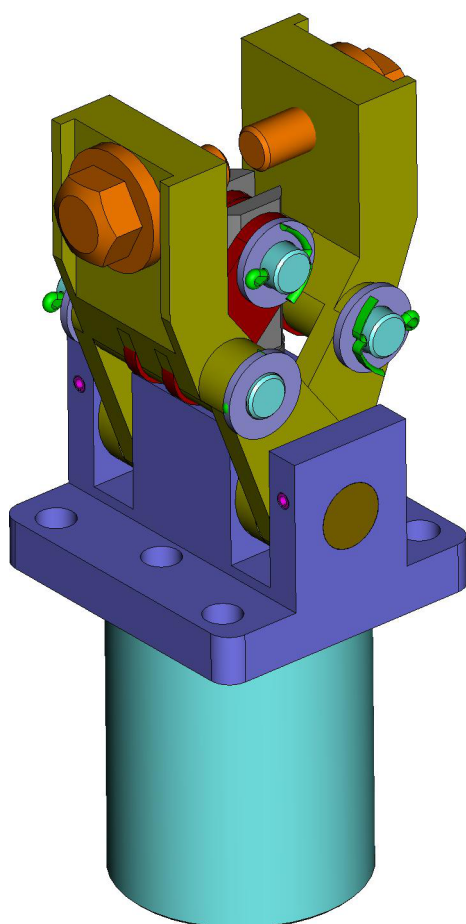

Механизм хватка

МХ-401-001

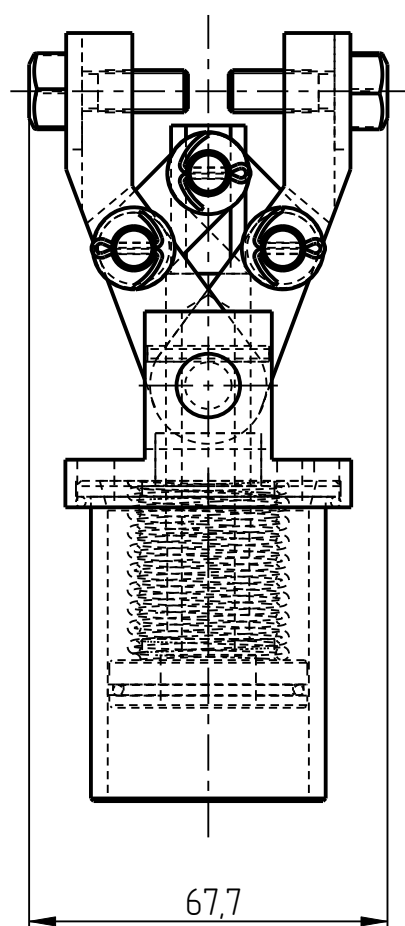
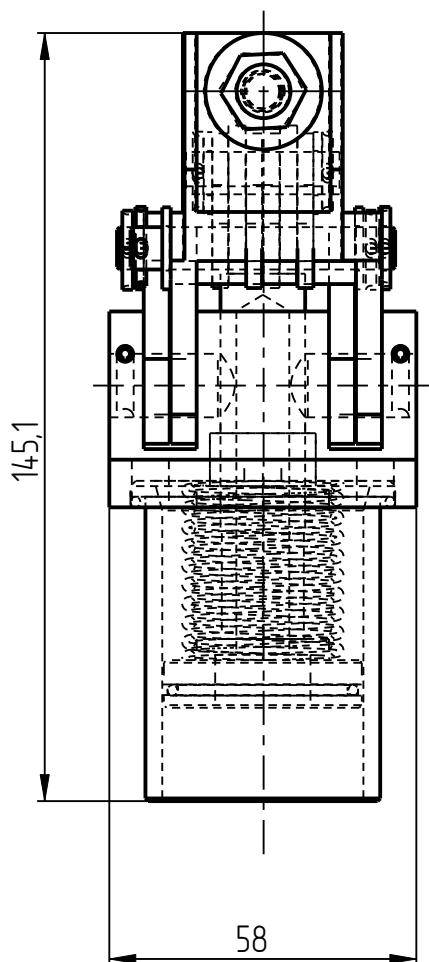

Механизм хватка МХ-401-001

Спецификация

№ поз.	Шифр	Наименование	Кол-во
Детали			
1	МХ-401-001-001	Корпус	1
2	МХ-401-001-002	Втулка	1
3	МХ-401-001-003	Цилиндр чугунный	1
4	МХ-401-001-004	Поршень	1
5	МХ-401-001-005	Пружина	1
6	МХ-401-001-006	Держатель хватка	2
7	МХ-401-001-007	Ось	2
8	МХ-401-001-008	Серьга	4
9	МХ-401-001-011	Ось	1
10	МХ-401-001-013	Кольцо	1
11	МХ-401-001-014	Ось	2
Стандартные изделия			
12	Шплинт 2x14 DIN 94		6
13	Штифт разрезной Ø3x24 DIN 1481		2
14	M10x20 DIN 6921		2
15	Кольцо 046-050-25 ГОСТ 9833-73		1
16	Шайба 8 DIN 125		6
17	Кольцо 032-036-25 ГОСТ 9833-73		1

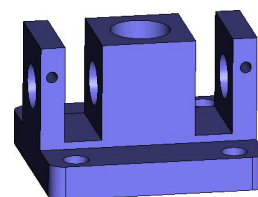
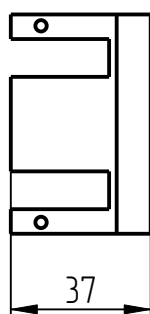
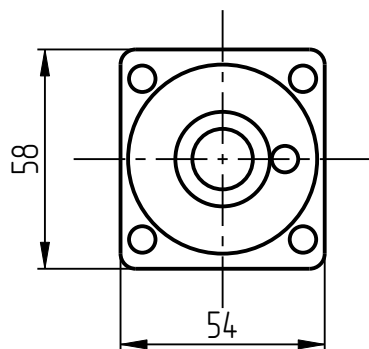

1. Корпус
MX-401-001-001

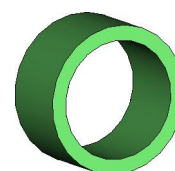
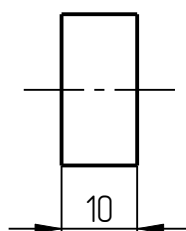
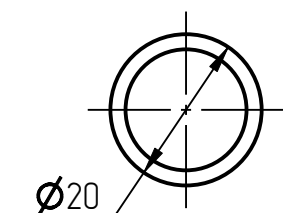

2. Втулка
MX-401-001-002

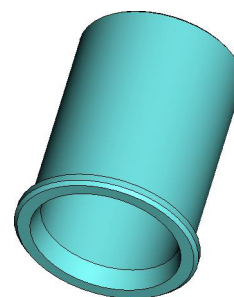
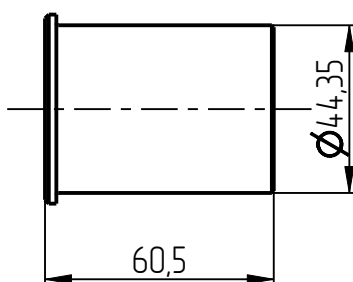
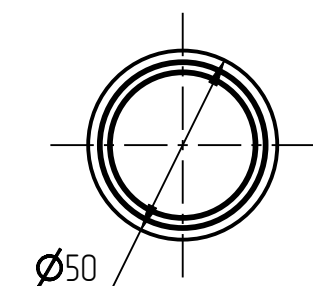

3. Цилиндр чугунный
MX-401-001-003

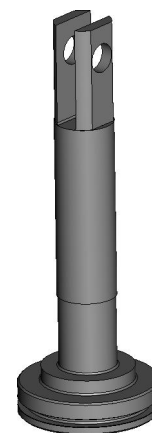
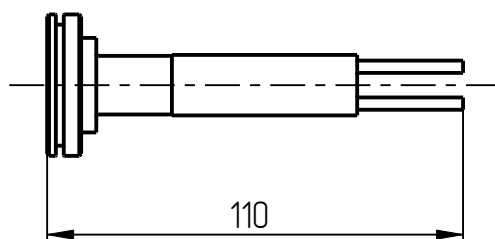
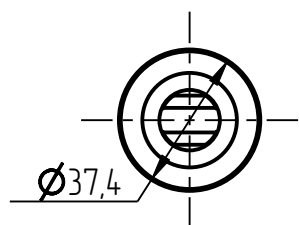

4. Поршень
MX-401-001-004

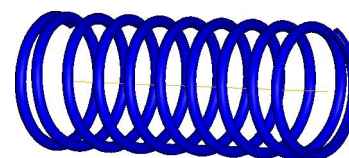
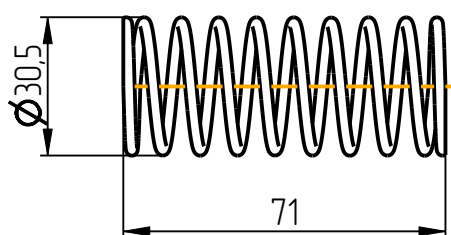

5. Пружина
MX-401-001-005

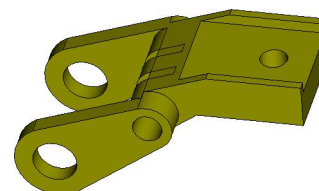
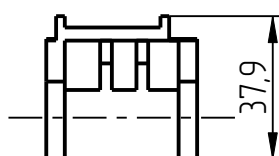
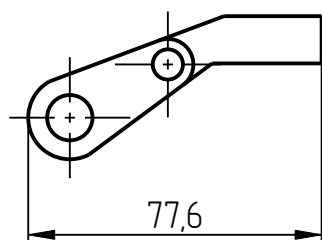

6. Держатель хватки
MX-401-001-006

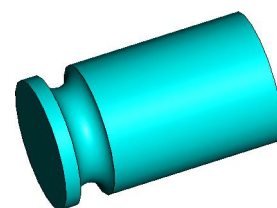
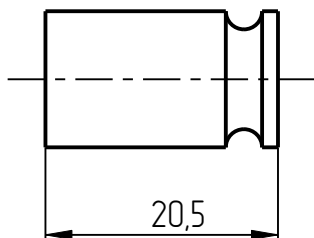
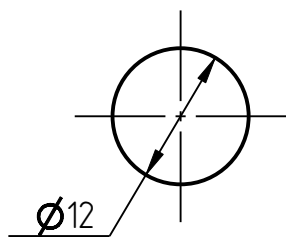

7. Ось
MX-401-001-007

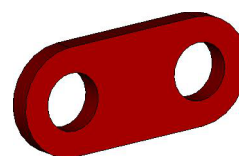
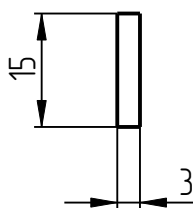
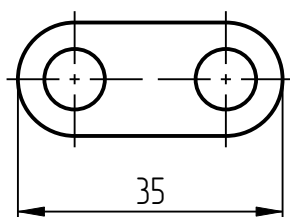

8. Серьга
MX-401-001-008

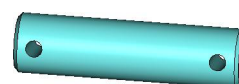
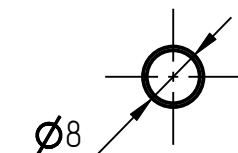
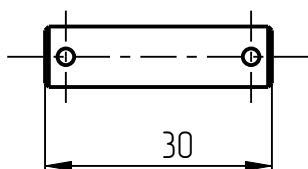

9. Ось
MX-401-001-011

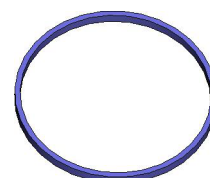
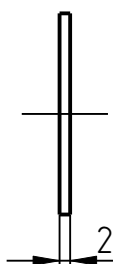
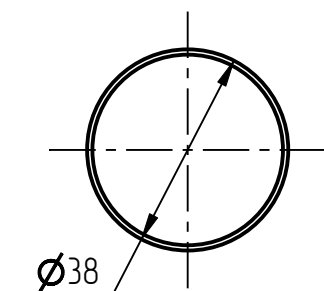

10. Кольцо
MX-401-001-013

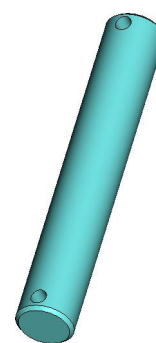
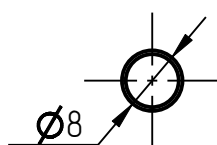
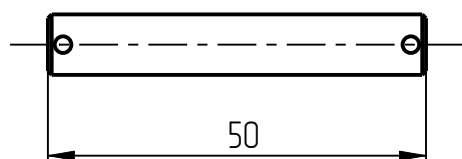

11. Ось
MX-401-001-014