

401

DV-401-009
ДЕРЖАТЕЛЬ ВОРОНОК
5 1/2"
(АЛ-140_89_1125663-1)

Держатель воронок DV-401-009 (5,5") (АЛ-140_89_1125663-1)

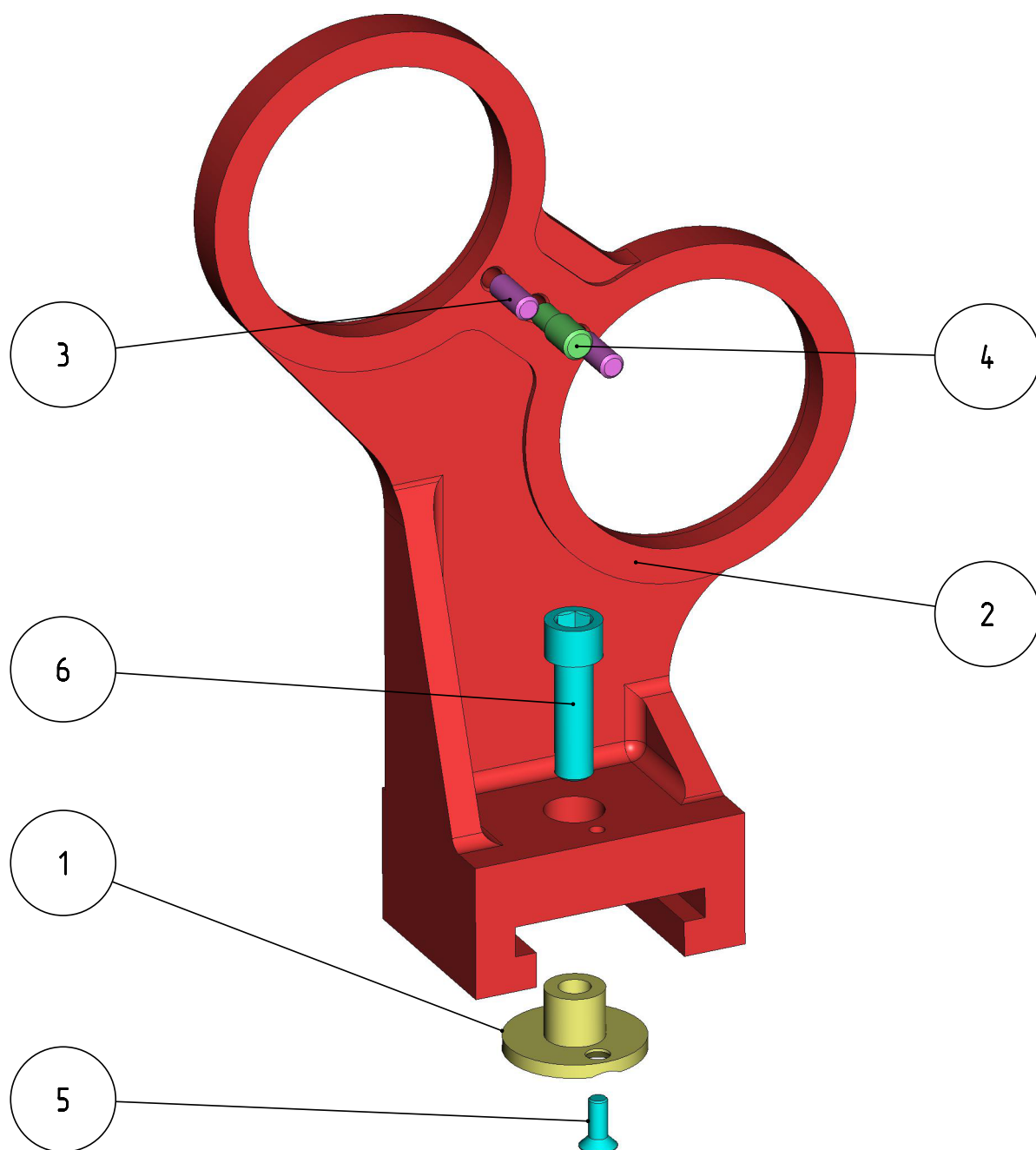

Держатель воронок DV-401-009 (5,5") (АЛ-140_89_1125663-1)

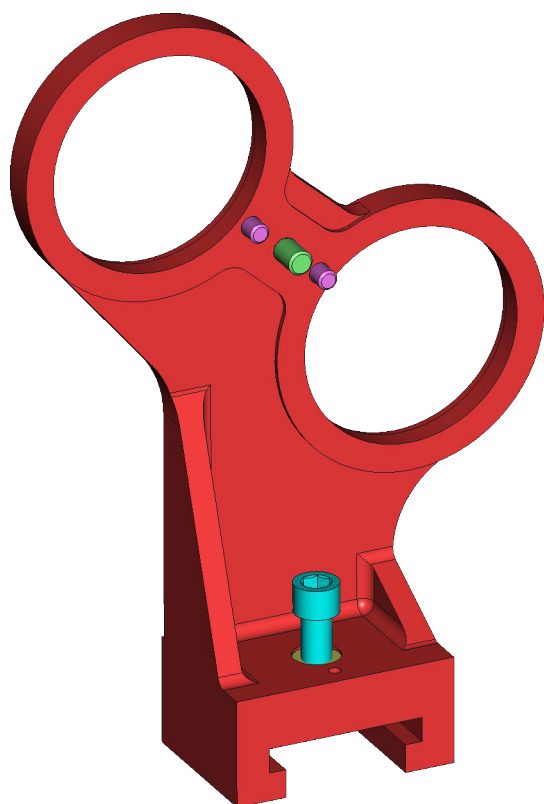

Держатель воронок DV-401-009 (5,5") (АЛ-140_89_1125663-1)

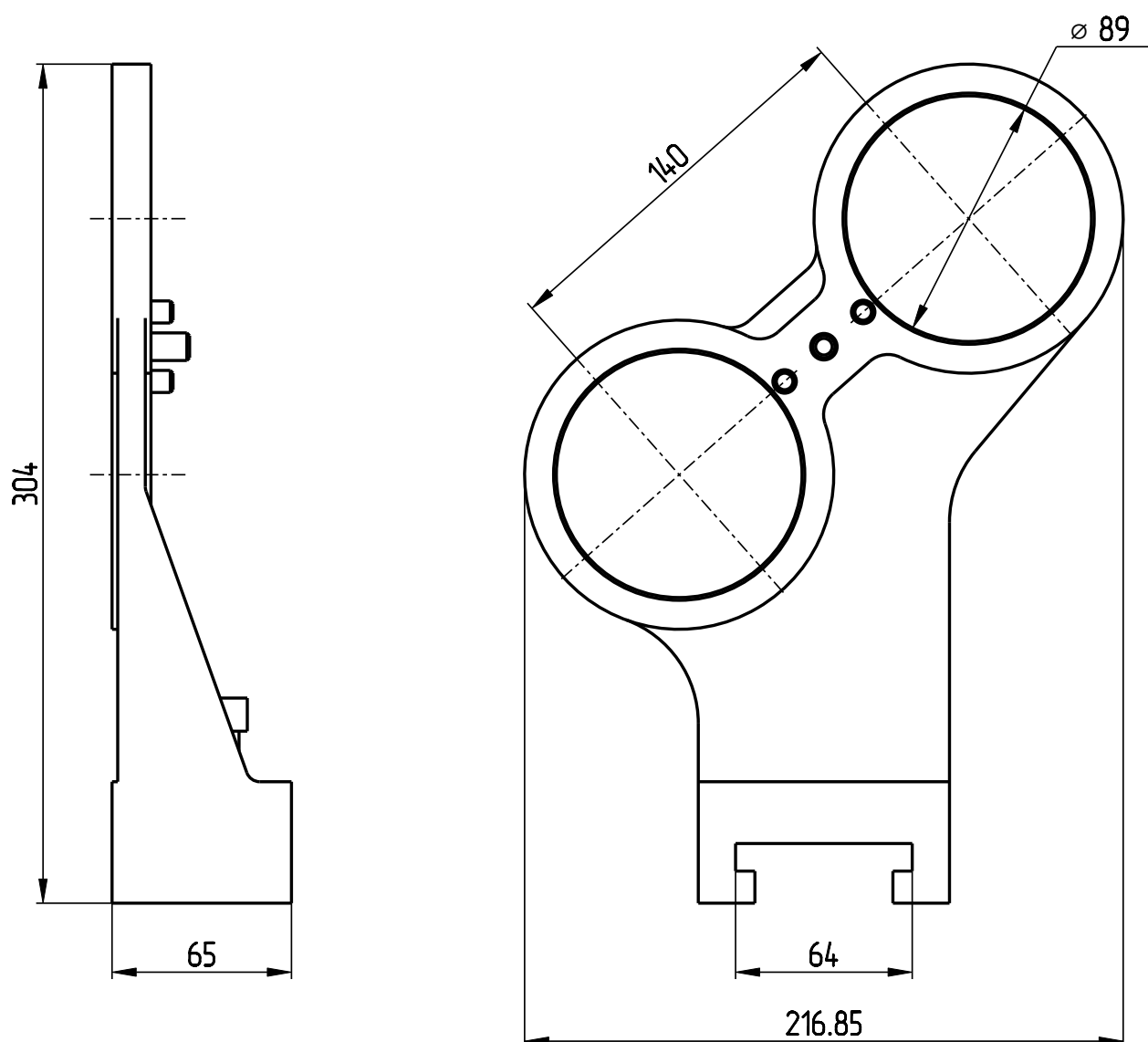

Держатель воронок DV-401-009 (5 1/2") (АЛ-140_89_1125663)
Спецификация

№ поз.	Шифр	Наименование	Кол-во
Детали			
1	KDG-V5-401	Втулка	1
2	DV-401-009-001	Плечо воронки	1
3	DV-401-009-002	Шпилька	2
4	DV-401-009-003	Штифт	1
Стандартные изделия			
5	Винт М6х16 DIN7991		1
6	Винт М12х40 DIN 912		1

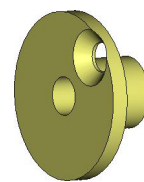
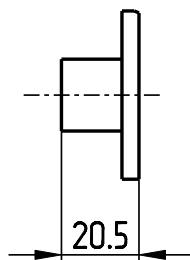
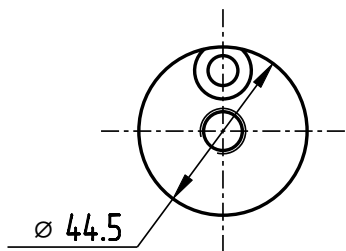

1. Втулка
KDG-V5-401

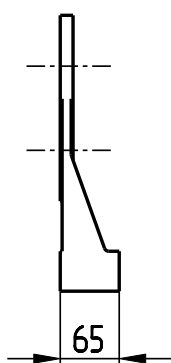
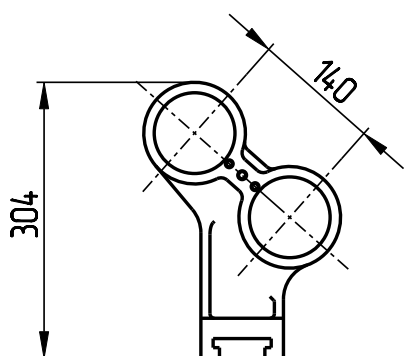

2. Плечо воронки
DV-401-009-001

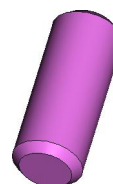
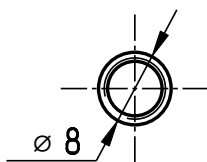
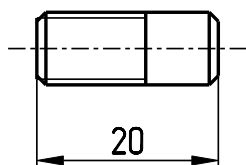

3. Шпилька
DV-401-009-002

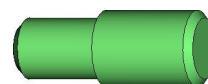
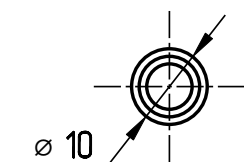
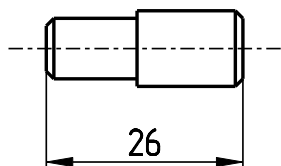

4. Штифт
DV-401-009-003