

401

ELP-401
VALVE
(0048VGD-02AB)

Valve ELP-401

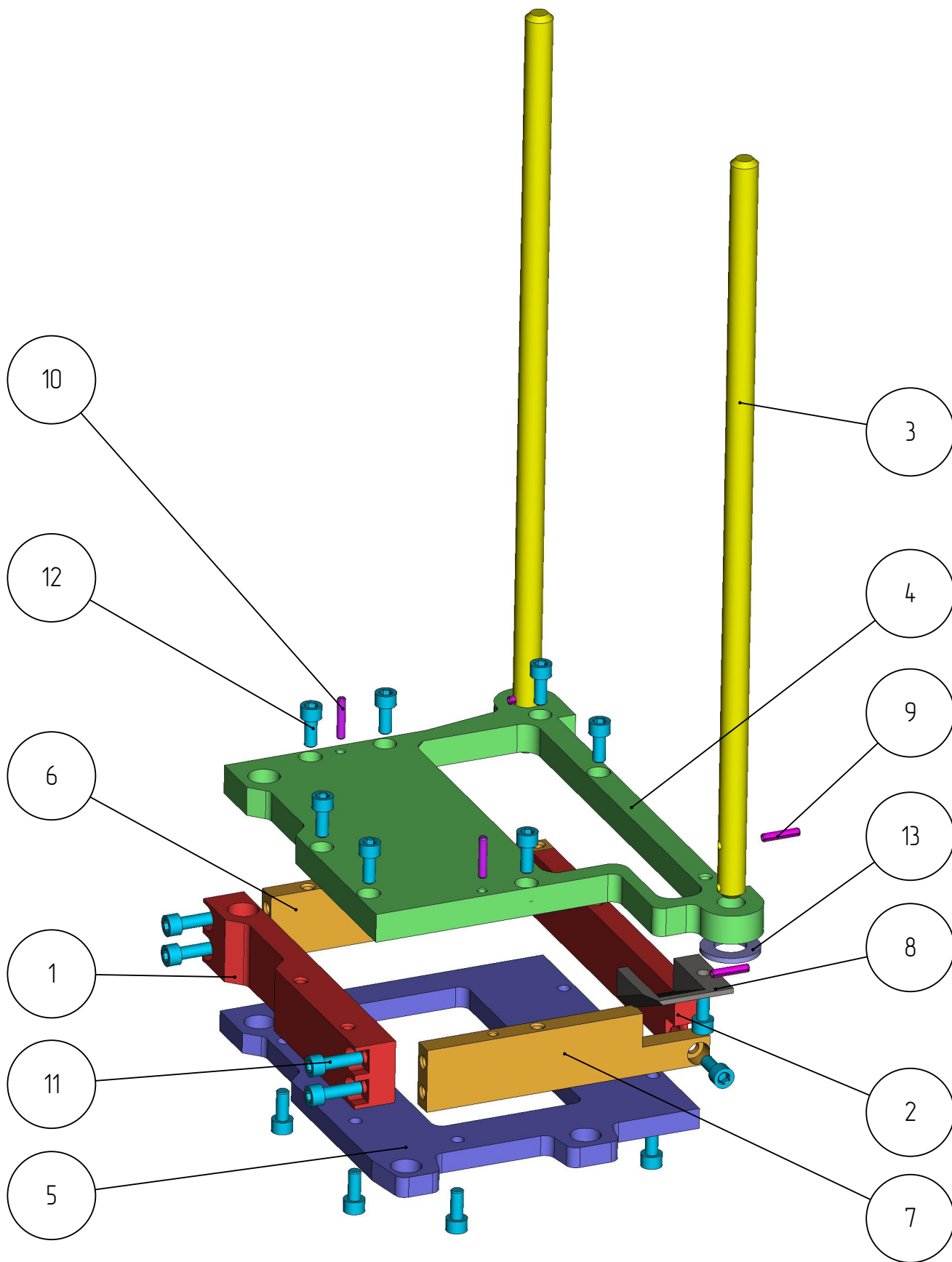

Valve ELP-401

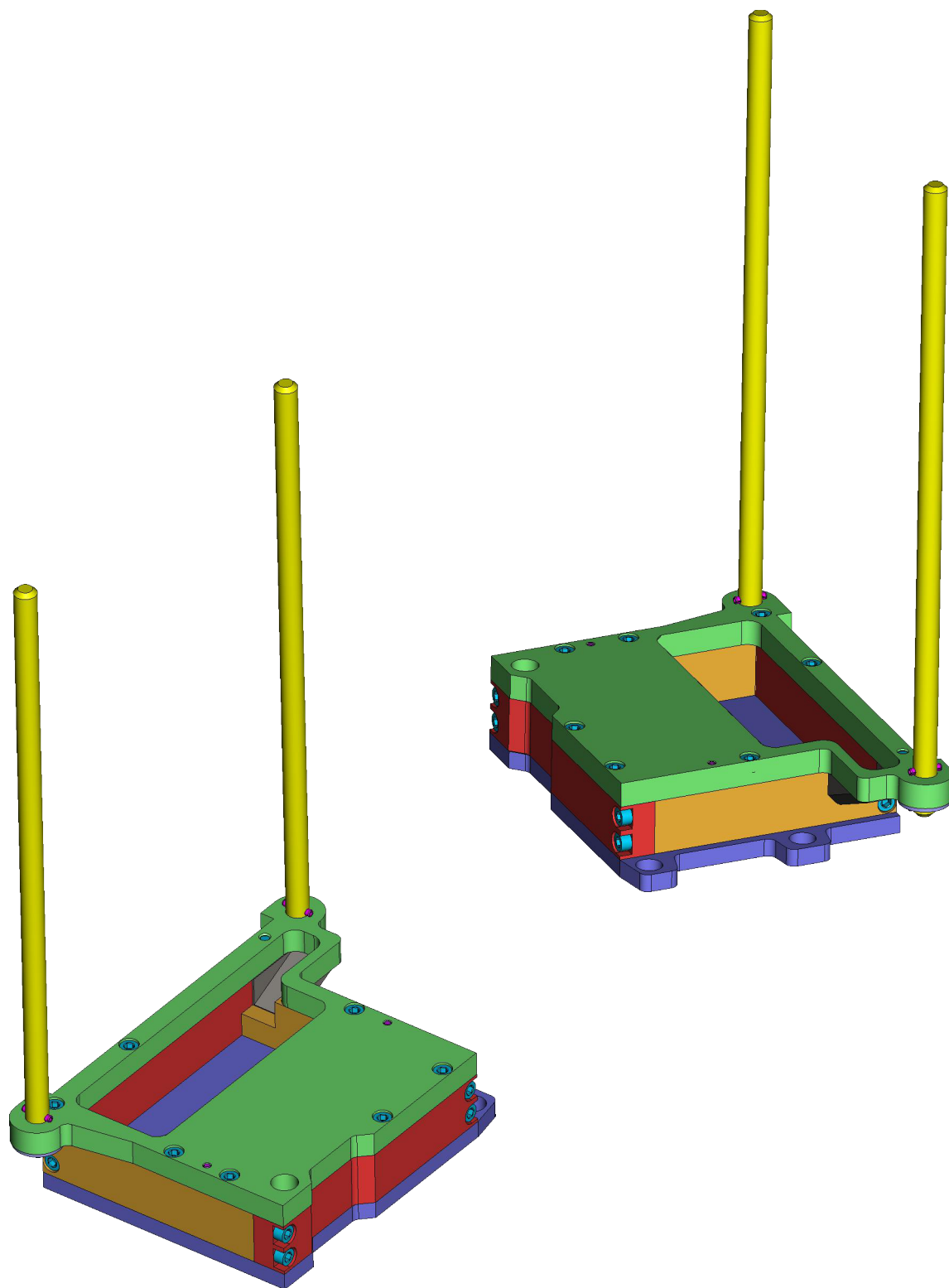

Valve ELP-401 Specification

№ pos.	Code	Name	Qty
Parts			
1	EL-401-005	Side wall	1
2	EL-401-007	Middle wall	1
3	EL-401-009	Bearing slide	2
4	ELP-401-002	Top plate	1
5	ELP-401-003	Bottom plate	1
6	ELP-401-006	Back wall	1
7	ELP-401-008-01	Front wall	1
8	ELP-401-008-02	Insert	1
Standard parts			
9	Spring pin 4x18 DIN 1481		4
10	Pin 4Гx20 DIN 6325		2
11	Screw M6x20 DIN 912		4
12	Screw M6x14 DIN 912		16
13	Washer 14 DIN 125		2

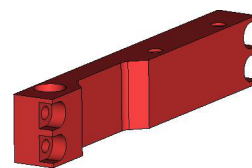
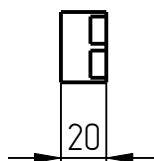
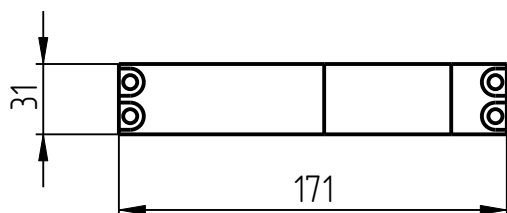

1. Side wall
EL-401-005

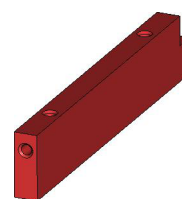
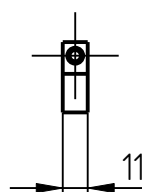
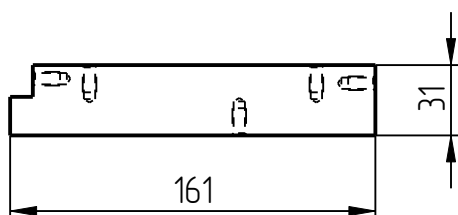

2. Middle wall
EL-401-007

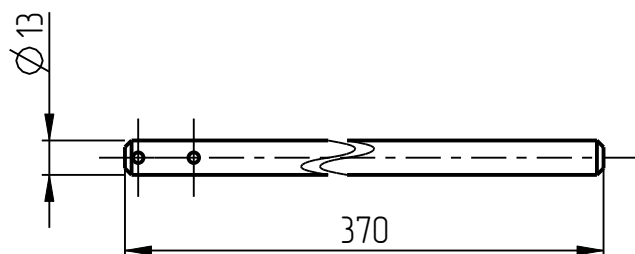

3. Bearing slide
EL-401-009

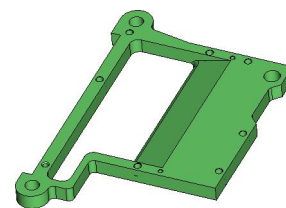
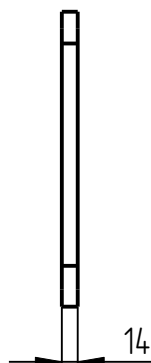
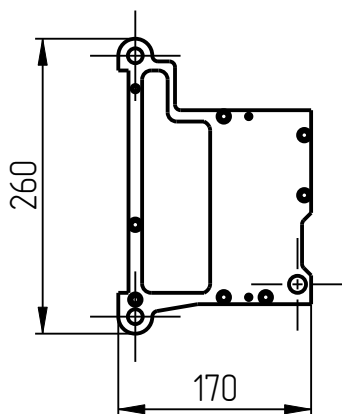

4. Top plate
ELP-401-002

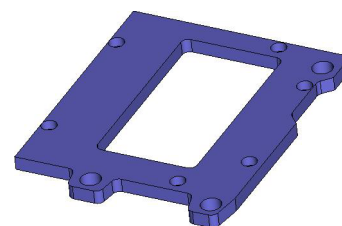
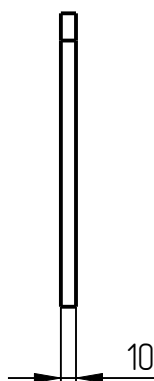
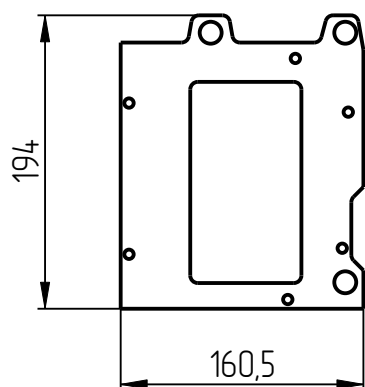

5. Bottom plate
ELP-401-003

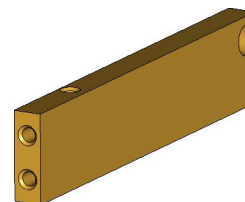
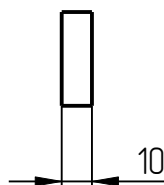
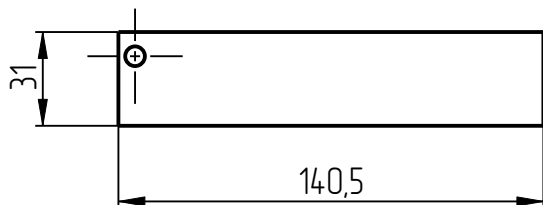

6. Back wall
ELP-401-006

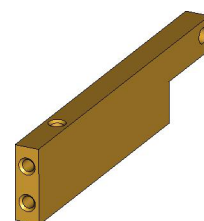
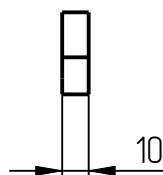
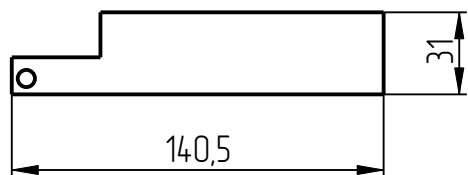

7. Front wall
ELP-401-008-01

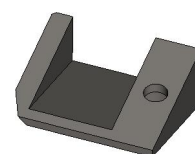
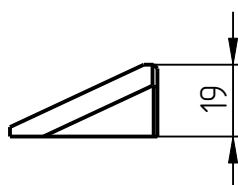
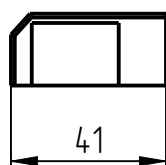

8. Insert
ELP-401-008-02