

401

ELP-401
КОРПУС СИСТЕМЫ
ОБДУВА ПРАВЫЙ
(0048VGD-02AB)

Корпус системы обдува ELP-401

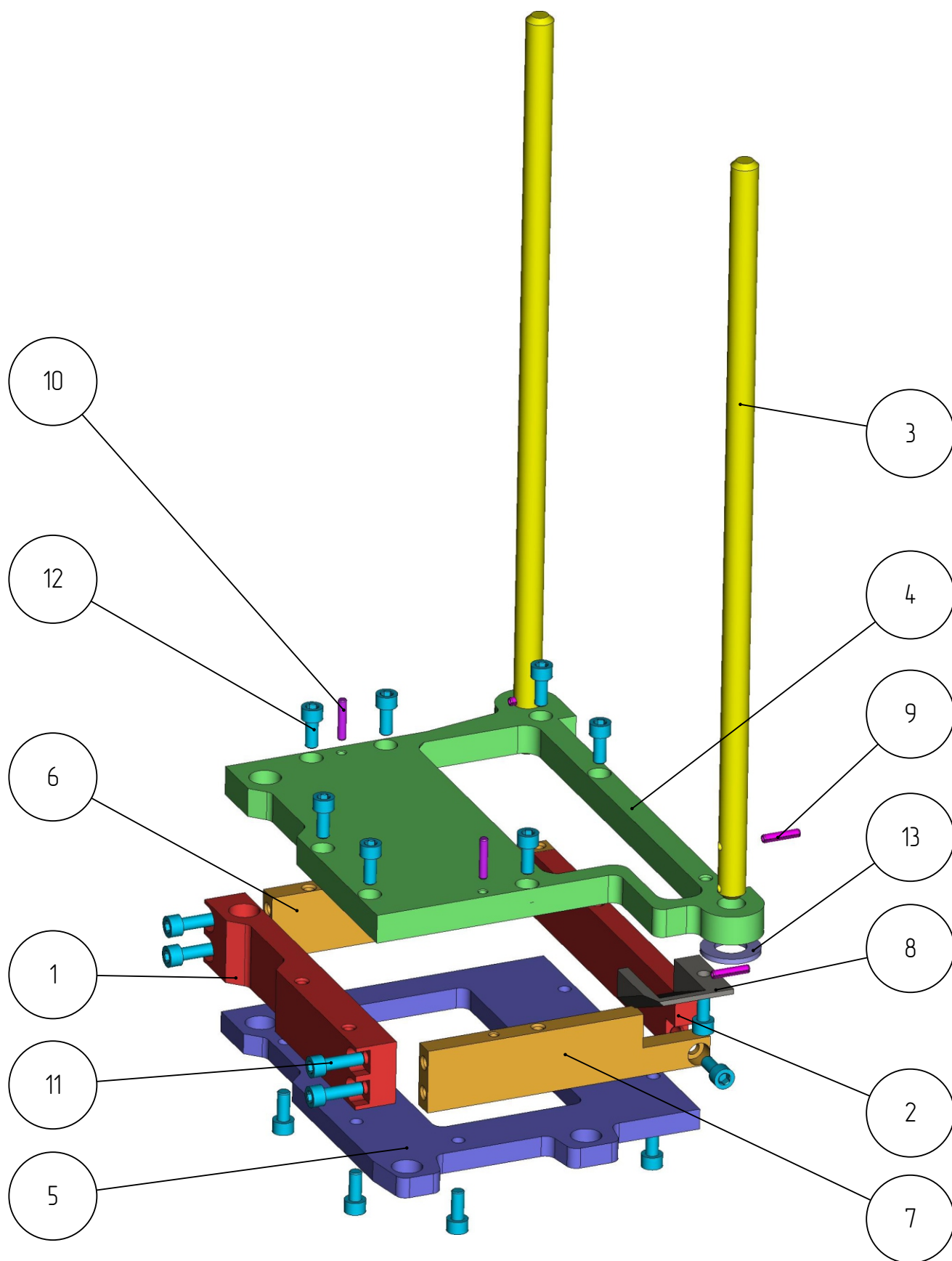

Корпус системы обдува ELP-401

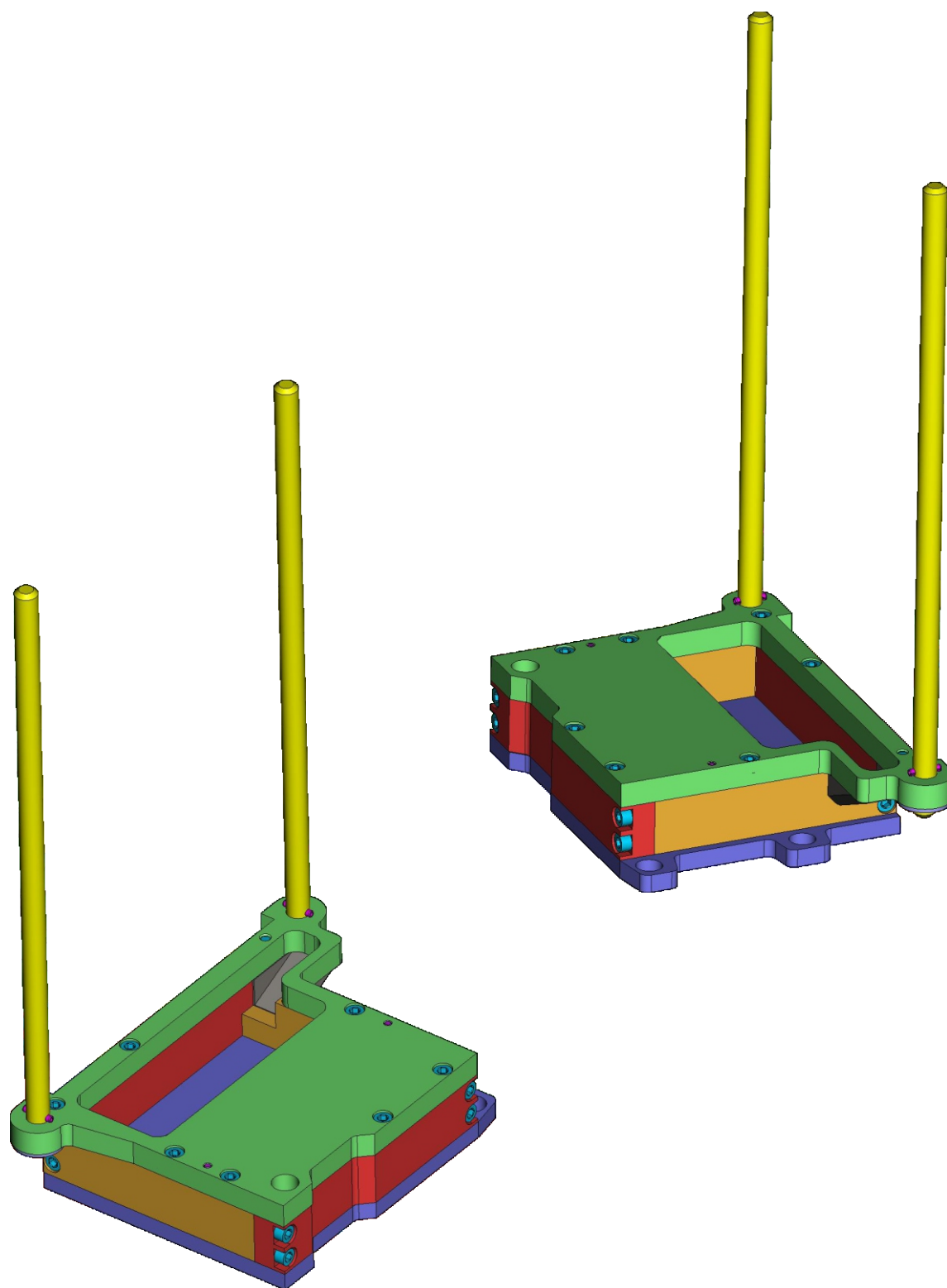

Клапан охлаждения ELP-401

Спецификация

№ поз.	Шифр	Наименование	Кол-во
Детали			
1	EL-401-005	Стенка боковая	1
2	EL-401-007	Стенка средняя	1
3	EL-401-009	Направляющий	2
4	ELP-401-002	Плита верхняя	1
5	ELP-401-003	Плита нижняя	1
6	ELP-401-006	Стенка задняя	1
7	ELP-401-008-01	Стенка передняя	1
8	ELP-401-008-02	Вставка	1
Стандартные изделия			
9	Штифт разрезной 4x18 DIN 1481		4
10	Штифт 4Гx20 DIN 6325		2
11	Винт М6x20 DIN 912		4
12	Винт М6x14 DIN 912		16
13	Шайба 14 DIN 125		2

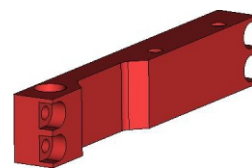
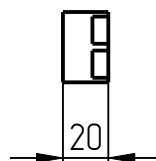
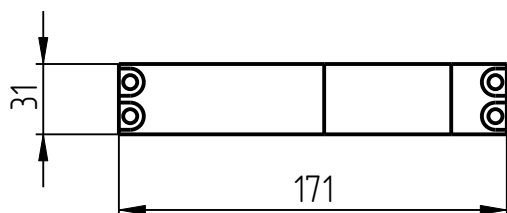

1. Стенка боковая
EL-401-005

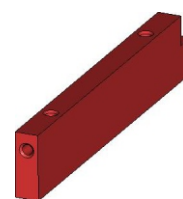
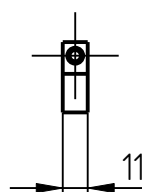
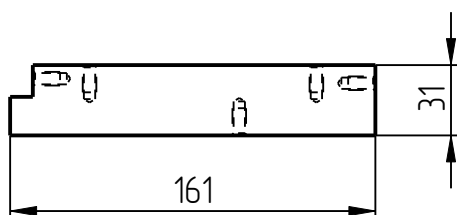

2. Стенка средняя
EL-401-007

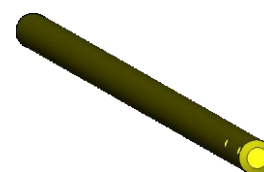
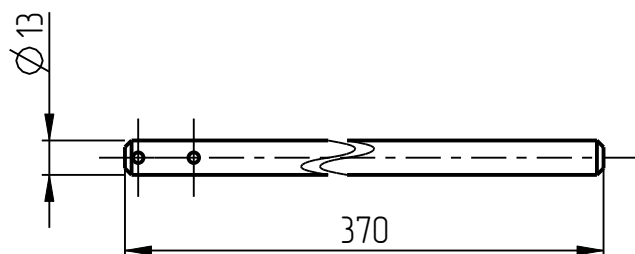

3. Направляющий
EL-401-009

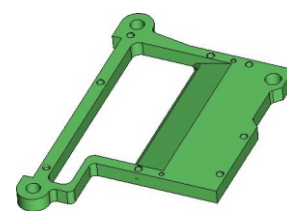
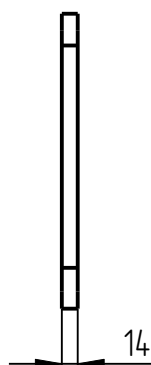
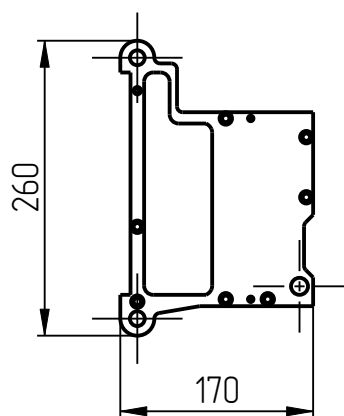

4. Плита верхняя
ELP-401-002

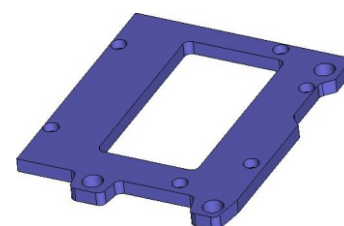
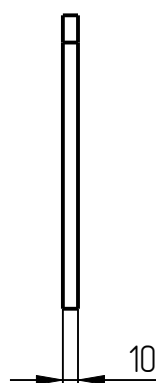
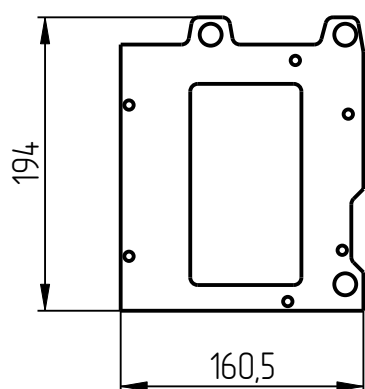

5. Плита нижняя
ELP-401-003

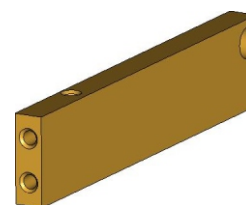
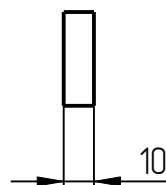
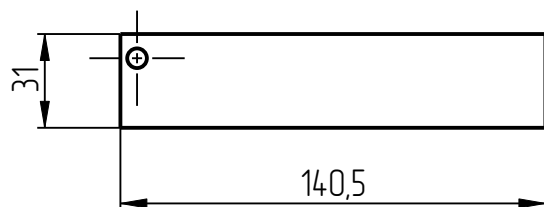

6. Стенка задняя
ELP-401-006

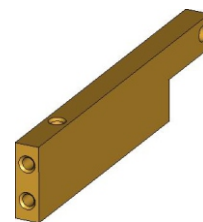
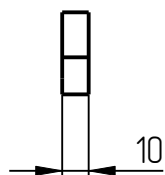
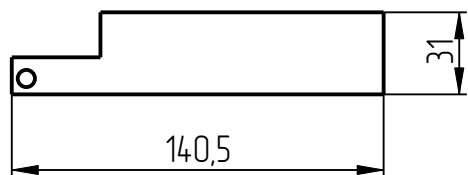

7. Стенка передняя
ELP-401-008-01

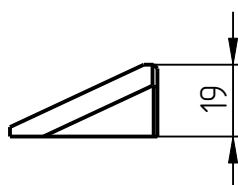
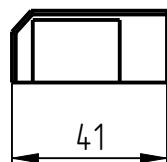

8. Вставка
ELP-401-008-02