

401

*DGK-401-017*  
*NECKRING HOLDER*  
*(MRN-401-AL-1112-2-1)*

Neckring holder DGK-401-017

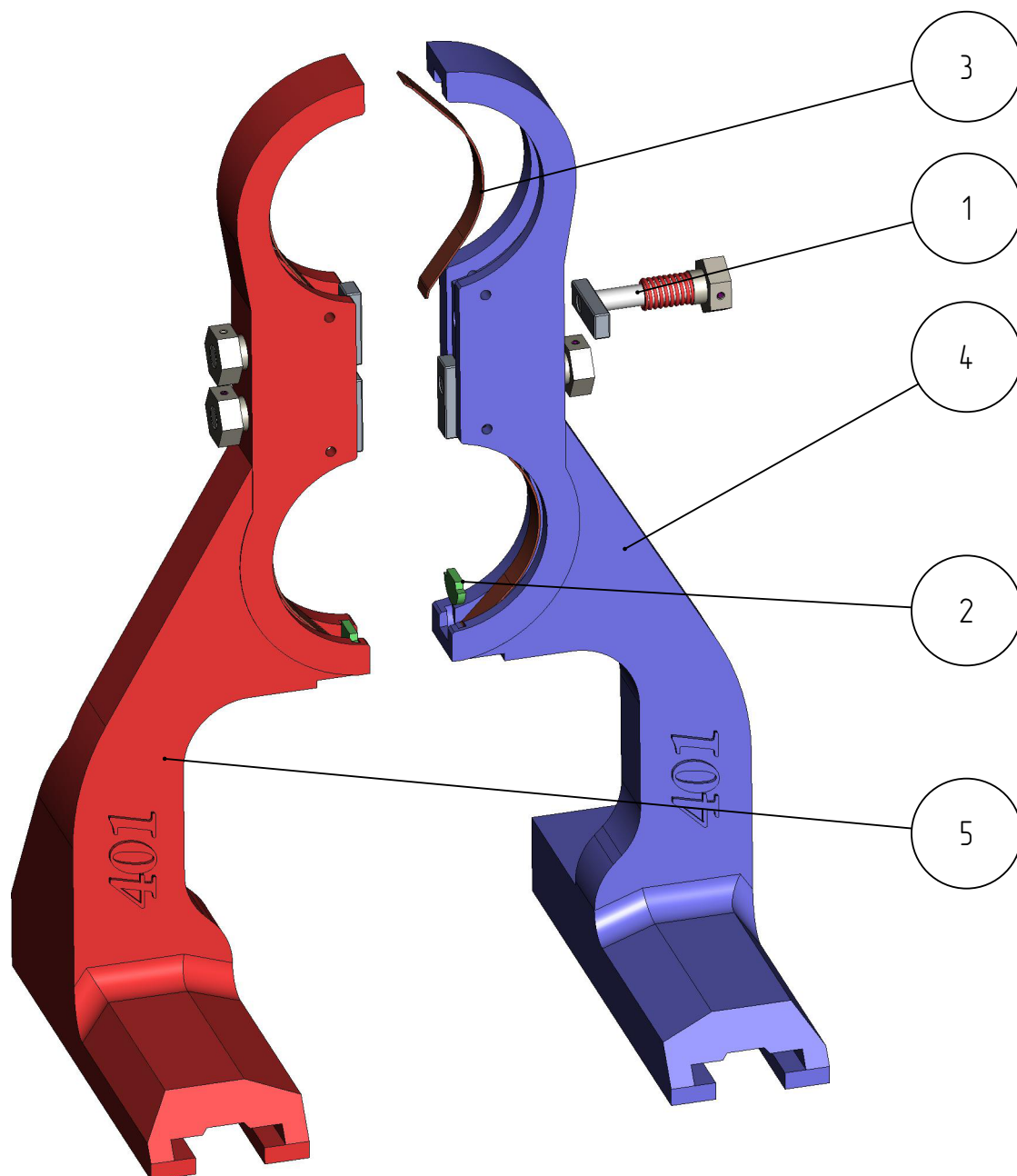

Neckring holder DGK-401-017

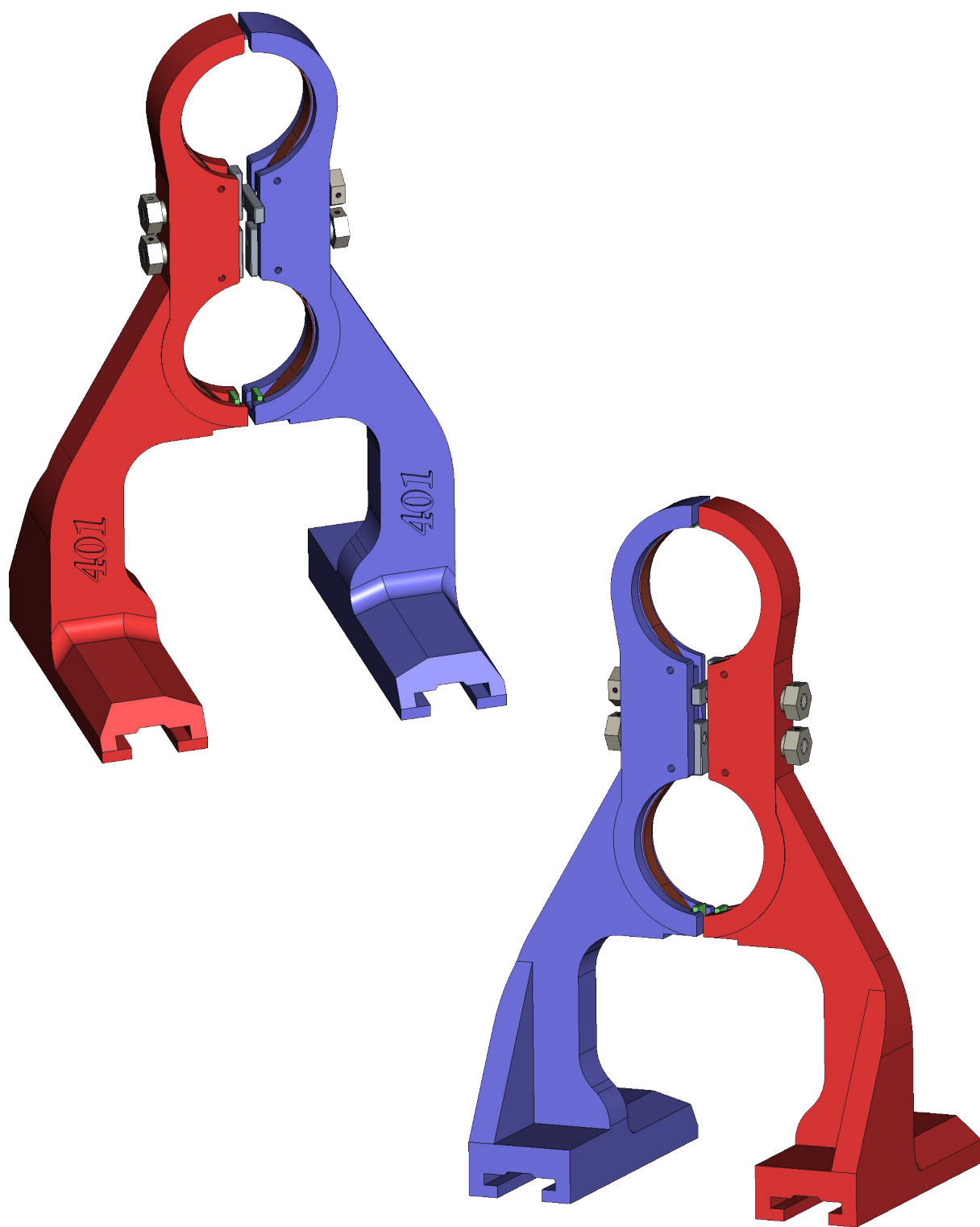

## Neckring holder DGK-401-017

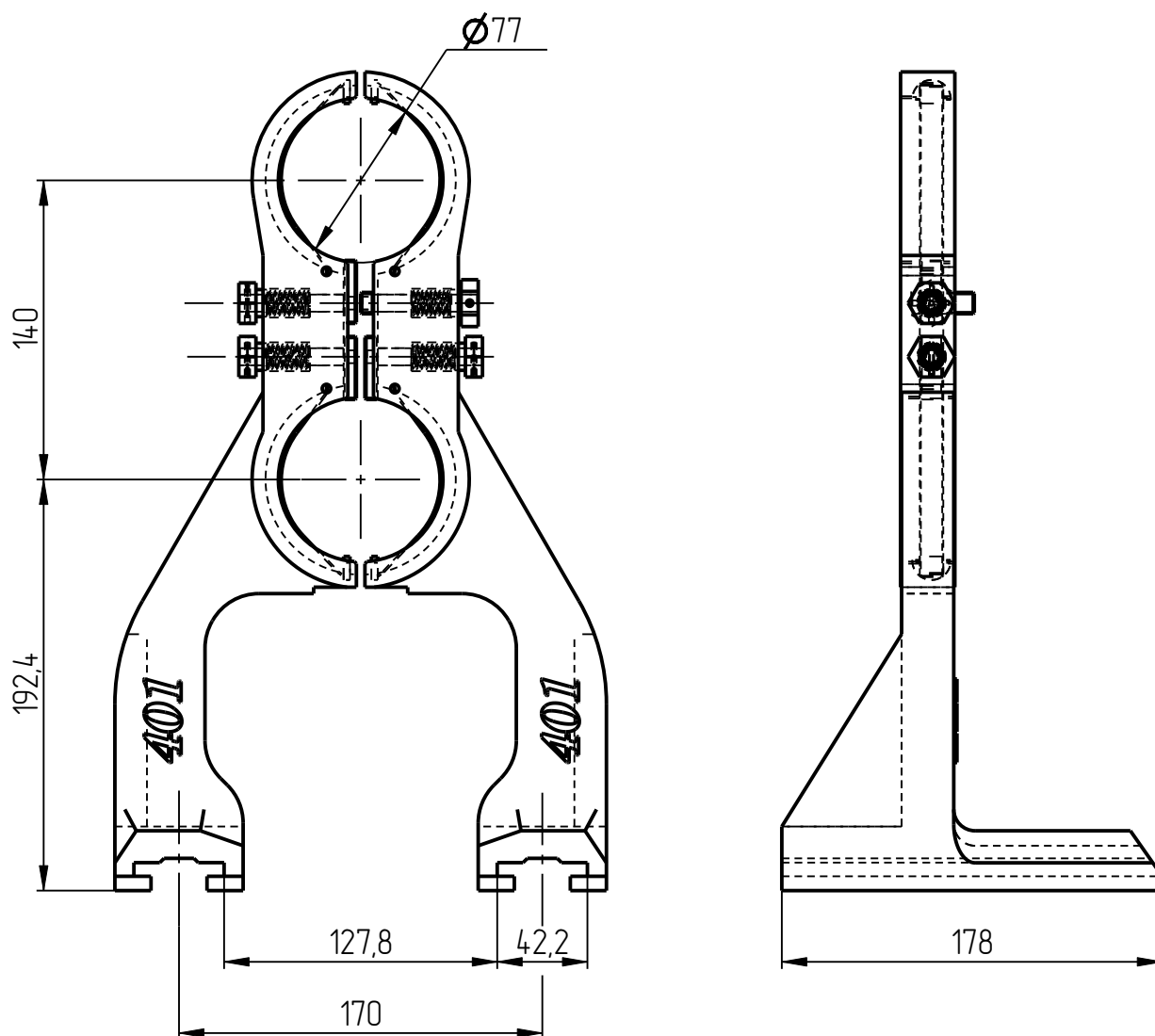

## Neckring holder DGK-401-015 Specification

№ pos.	Code	Name	Qty
<b>Assemblies</b>			
1	DGK-401-016-002	Lock	4
<b>Unified parts</b>			
2	DGK-401-STANDART-01	Stop	4
3	DGK-401-STANDART-05-L106	Leaf spring	4
<b>Parts</b>			
4	DGK-401-017-001	Neckring holder LH	1
5	DGK-401-017-001-01	Neckring holder RH	1

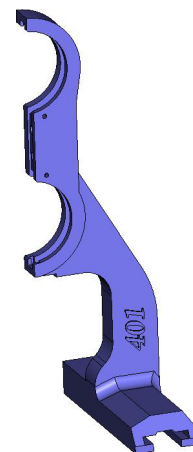
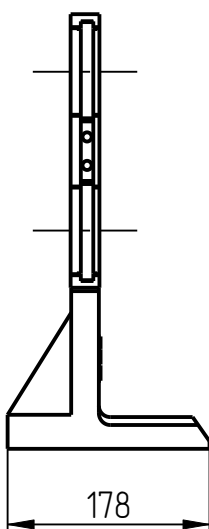
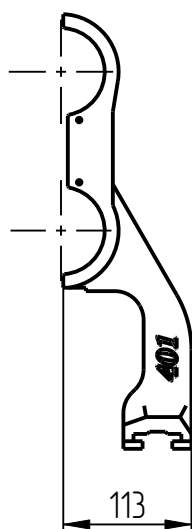

5. Neckring holder LH  
DGK-401-017-001

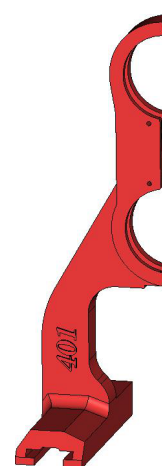
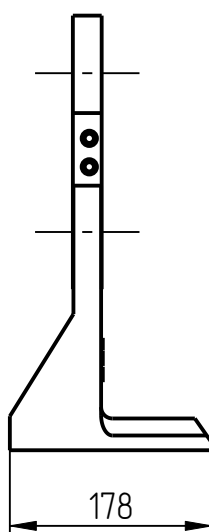
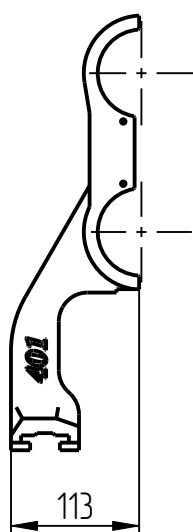

4. Neckring holder RH  
DGK-401-017-001-01