

401

*DGK-KP-401-002*  
*СТЕНД ПОВЕРОЧНЫЙ*  
*ДЕРЖАТЕЛЕЙ*  
*ГОРЛОВЫХ КОЛЕЦ 5-1/2"*

## Контрольное приспособление DGK-KP-401-002

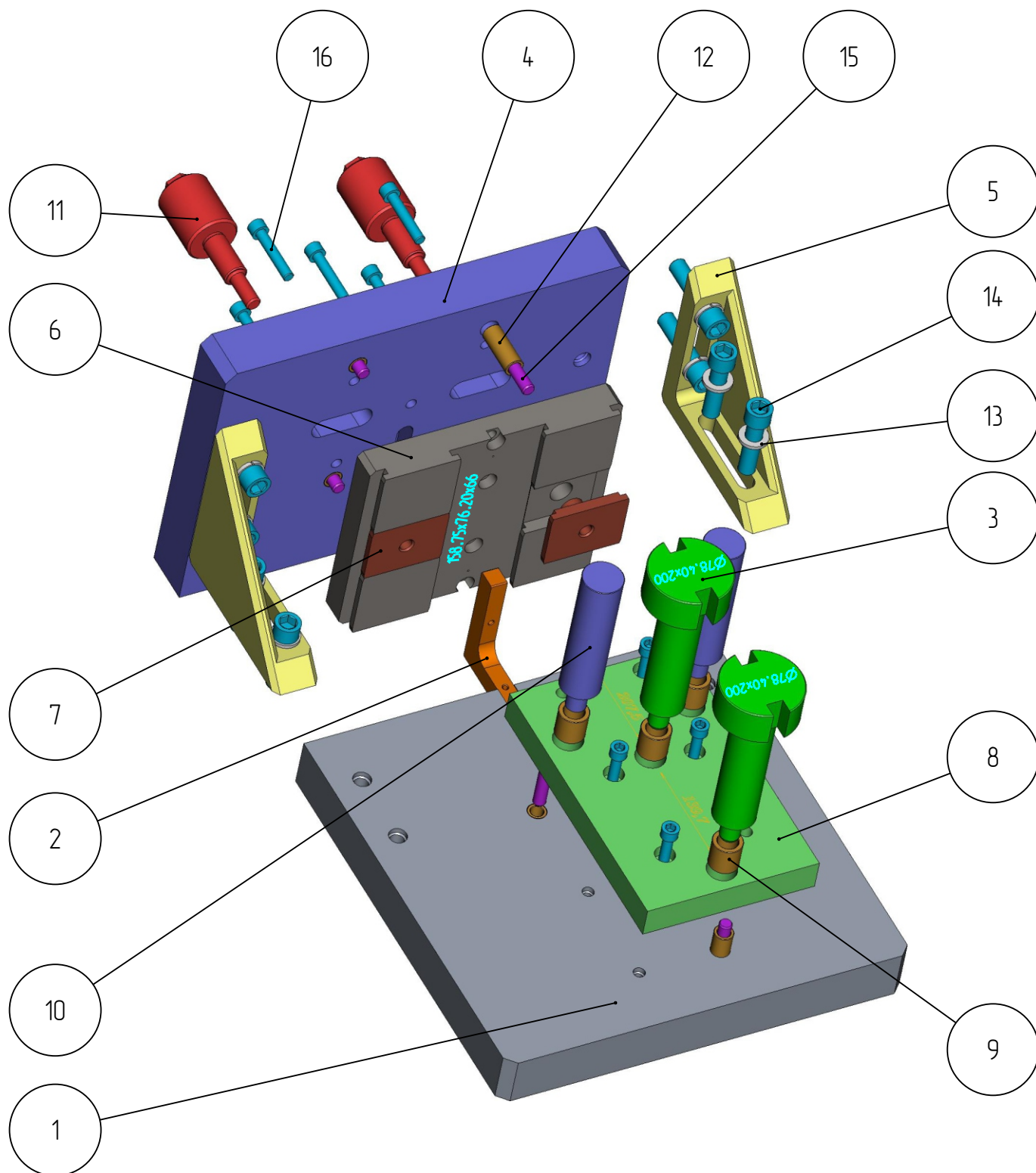

## Контрольное приспособление DGK-КР-401-002

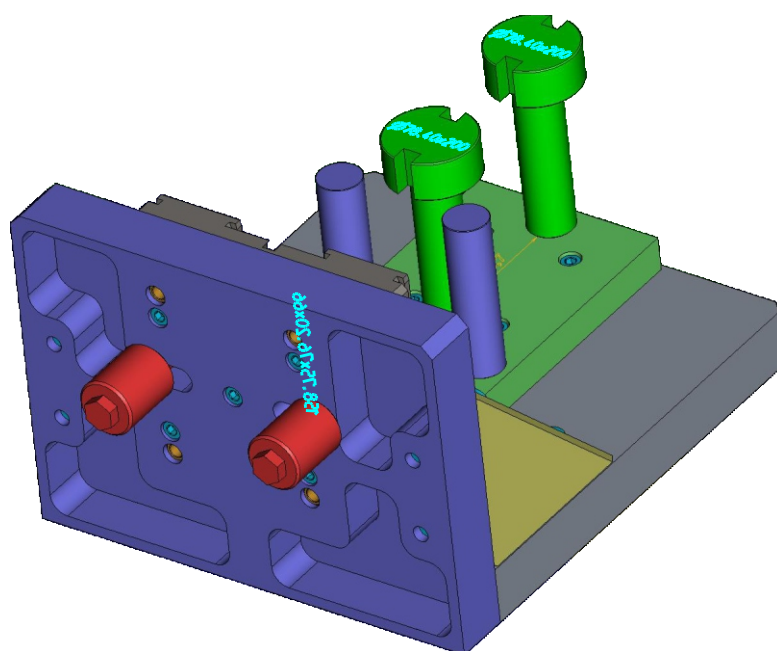
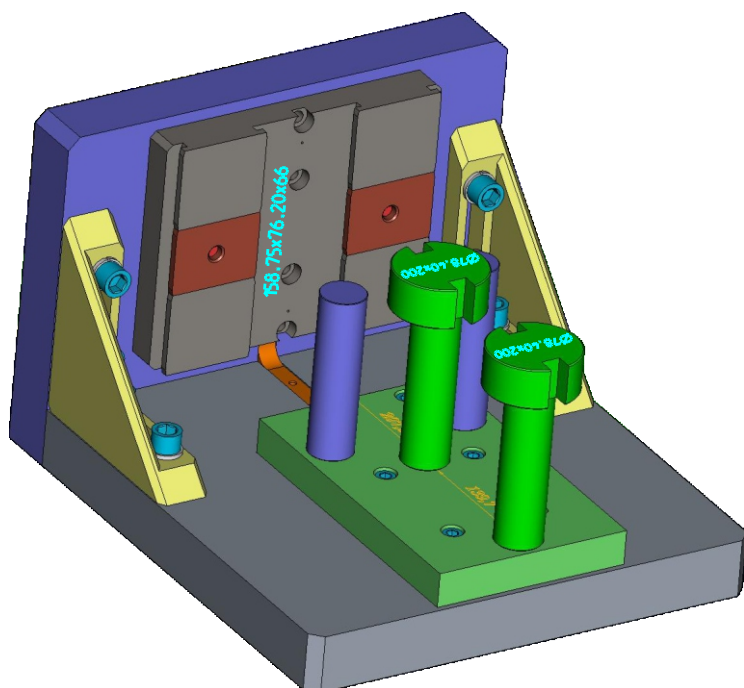

## Контрольное приспособление DGK-KP-401-002

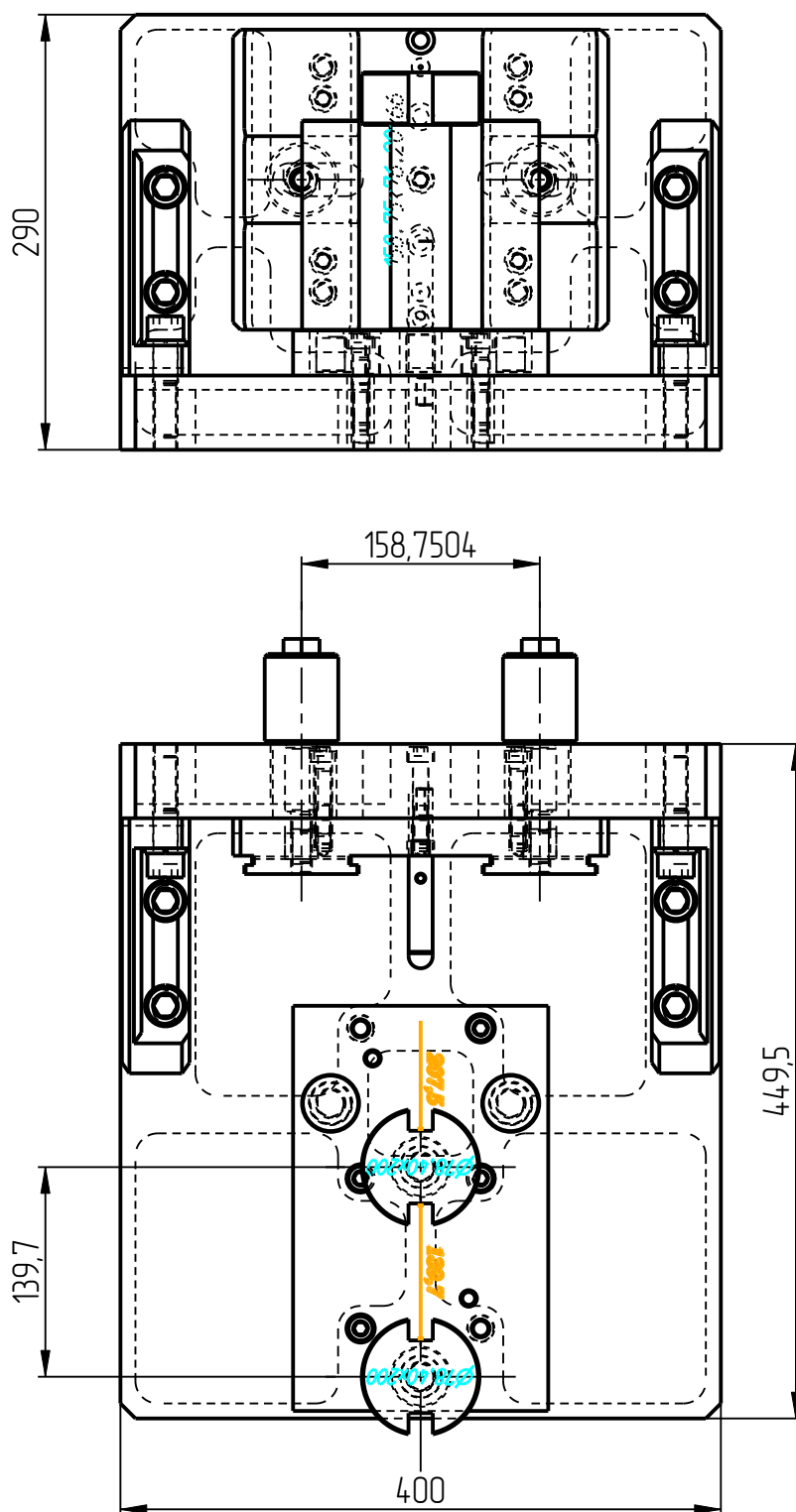

## Стенд поверочный DGK-КР-401-002 Спецификация

№ поз.	Шифр	Наименование	Кол-во
<b>Детали</b>			
1	DGK-КР-1-1	Основание	1
2	DGK-КР-1-10	Уголок	1
3	DGK-КР-1-12	Калибр ДГК	2
4	DGK-КР-1-2	Стенка	1
5	DGK-КР-1-3	Угол	2
6	DGK-КР-1-4-1	Направляющая	1
7	DGK-КР-1-4-1-1	Фиксатор	2
8	DGK-КР-1-5-3	Измерительная плита	1
9	DGK-КР-1-6	Втулка	4
10	DGK-КР-1-7	Опора	2
11	DGK-КР-1-8	Винт	2
12	DGK-КР-1-9	Втулка	6
<b>Стандартные изделия</b>			
13	Шайба пружинная В16-А4 DIN 127		8
14	Винт М16х65 DIN 912		8
15	Штифт 12Гх45 DIN 6325		6
16	Винт М10х55 DIN 912		9

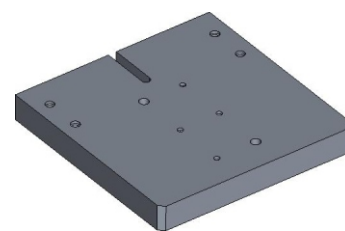
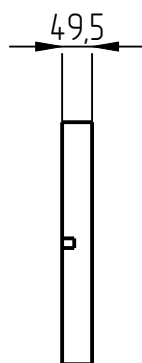
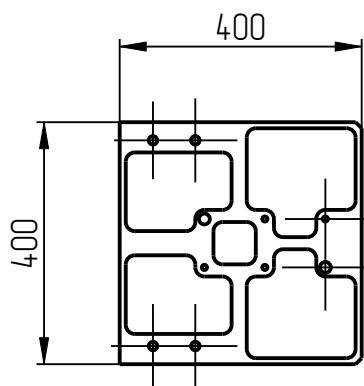

1. Основание  
DGK-КР-1-1

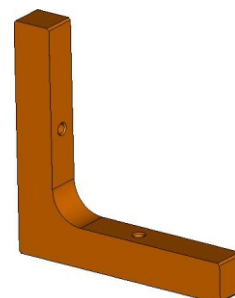
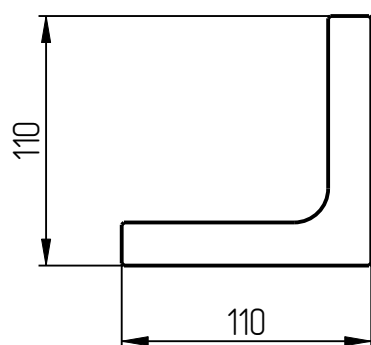

3. Узлоок  
DGK-КР-1-10

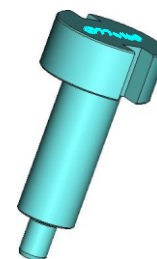
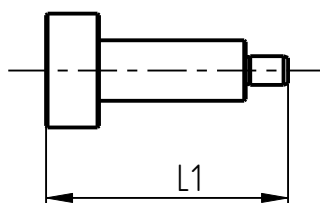
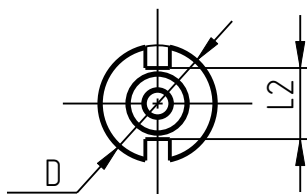

3. Калибр ДГК  
DGK-КР-1-12

Обозначение	$\varnothing D$ , мм	L1, мм	L2, мм
DGK-КР-1-12_68_2X160	68,2	160	38,2
DGK-КР-1-12_77X160	77	160	47
DGK-КР-1-12_78_4X160	78,4	160	48,4
DGK-КР-1-12_78_4X200	78,4	200	48,4
DGK-КР-1-12_78_9X160	78,9	160	48,9
DGK-КР-1-12_87X160	87	160	57
DGK-КР-1-12_95_2X160	95,2	160	65,2
DGK-КР-1-12_96X160	96	160	66

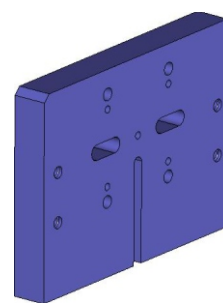
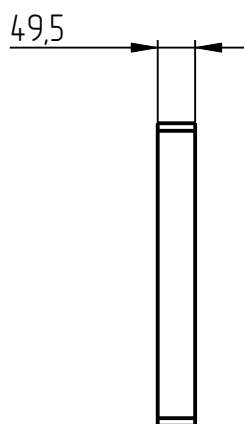
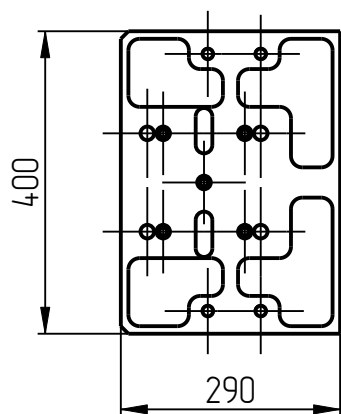

4. Стенка  
DGK-KP-1-2

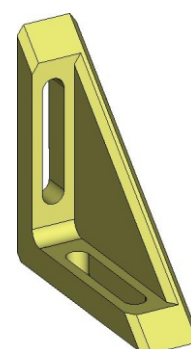
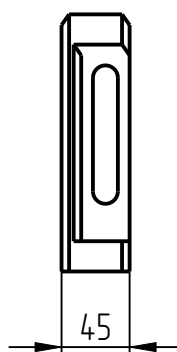
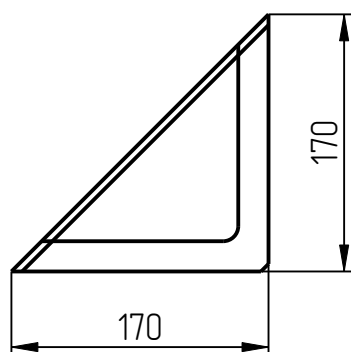

5. Узел  
DGK-KP-1-3

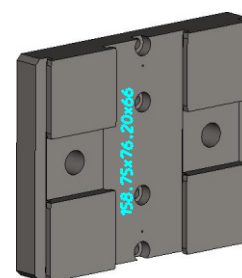
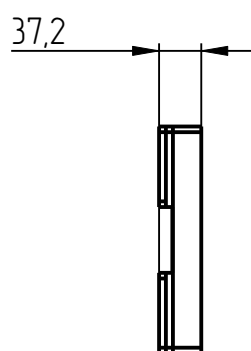
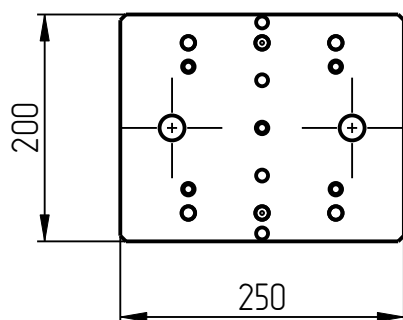

6. Направляющая  
DGK-KP-1-4-1

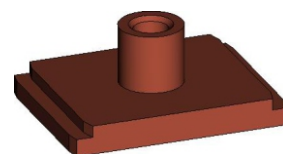
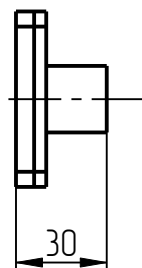
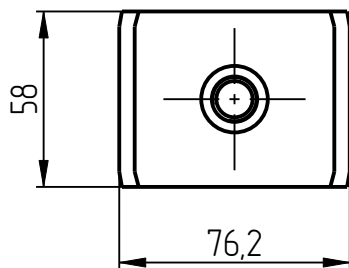

7. Фиксатор  
DGK-KP-1-4-1-1

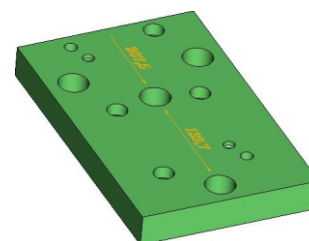
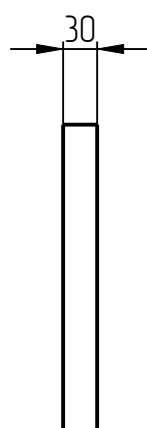
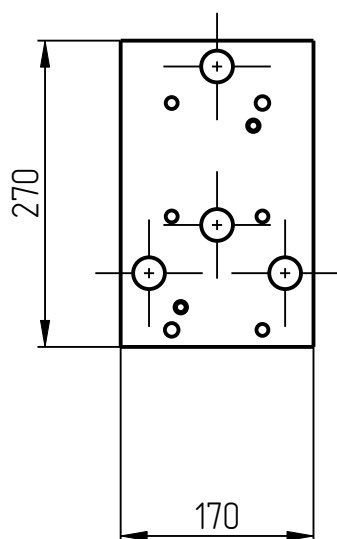

8. Измерительная плита  
DGK-KP-1-5-3

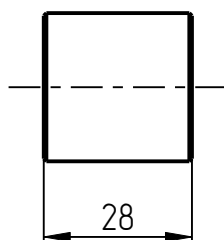
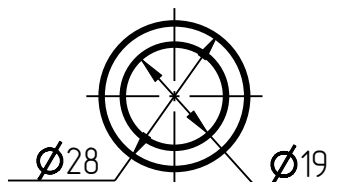

9. Втулка  
DGK-KP-1-6

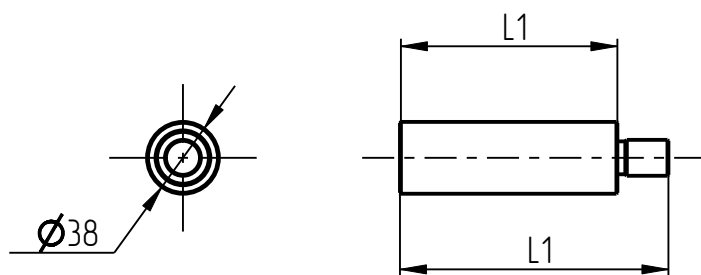

10. Опора  
DGK-KP-1-7

Обозначение	L1, мм	L2, мм
DGK-KP-1-7_L140 L140	140	167
DGK-KP-1-7_L120 L120	120	147
DGK-KP-1-7_L100 L100	100	127

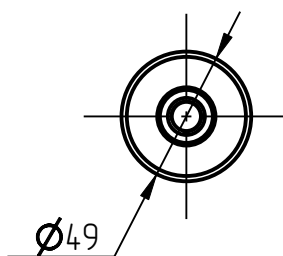
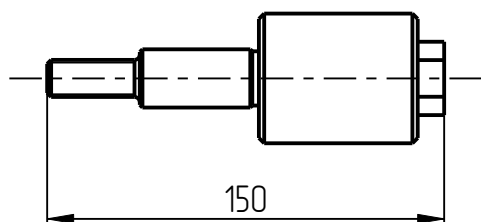

11. Винт  
DGK-KP-1-8

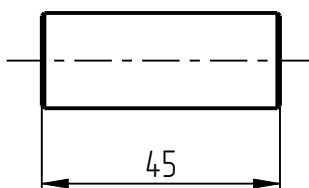
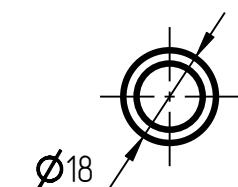

12. Втулка  
DGK-KP-1-9