

401

*DPG-401-004*  
*BAFFLE HOLDER 5,5"*  
*(125973)*

Baffle holder DPG-401-004

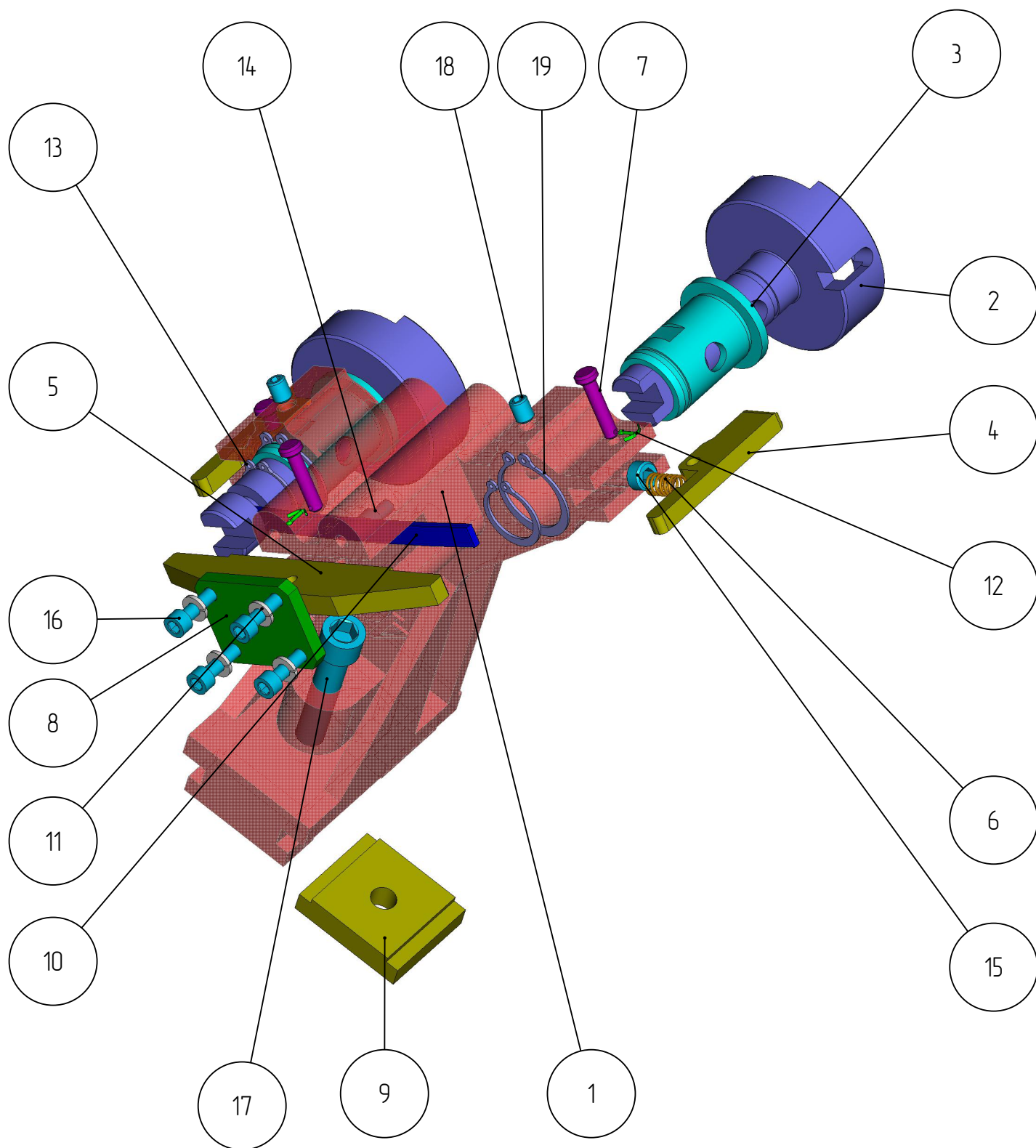

Baffle holder DPG-401-004

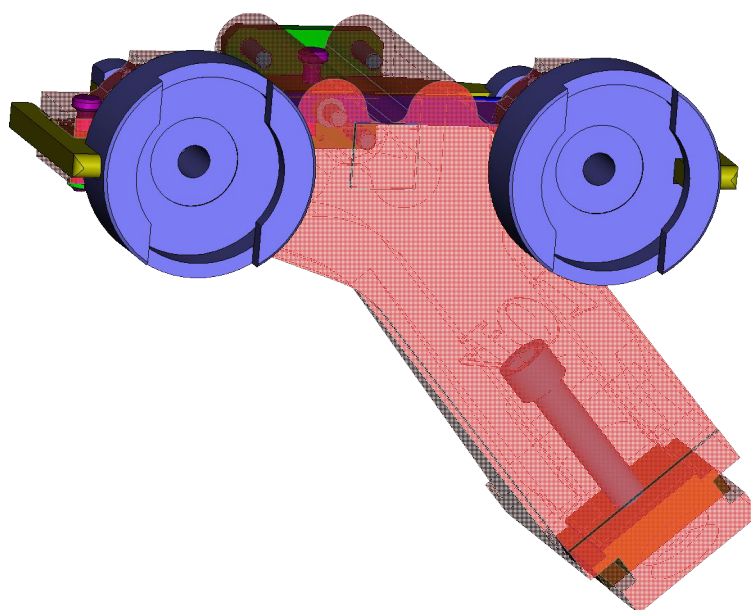
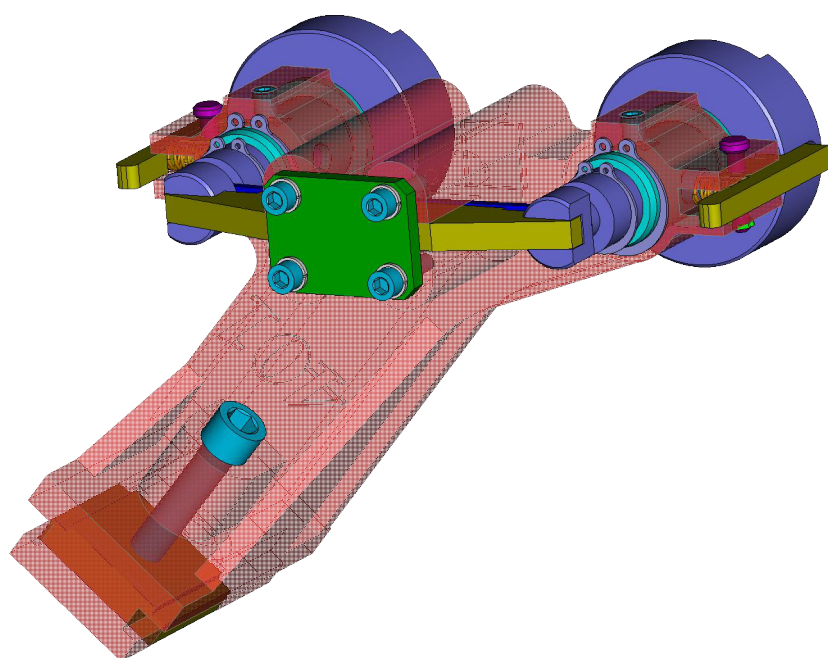

## Baffle holder DPG-401-004

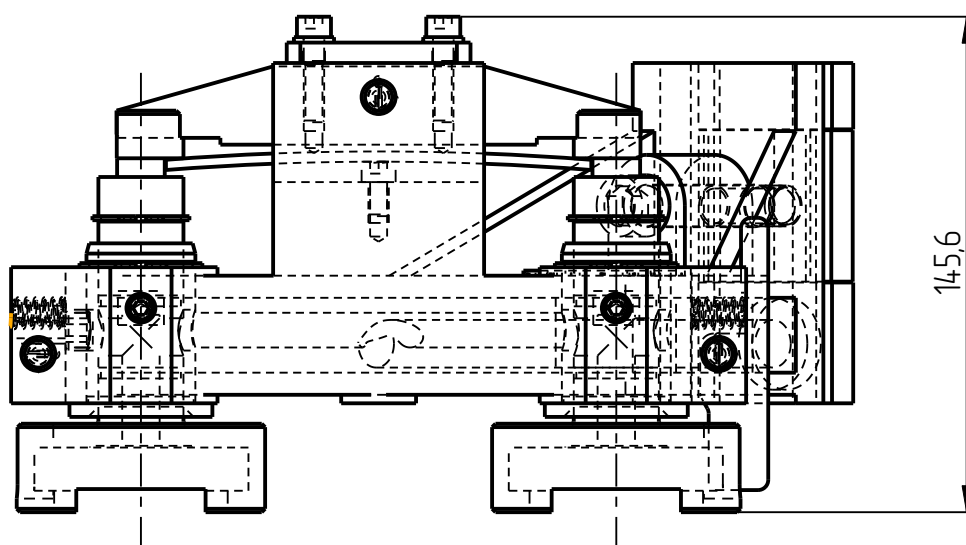
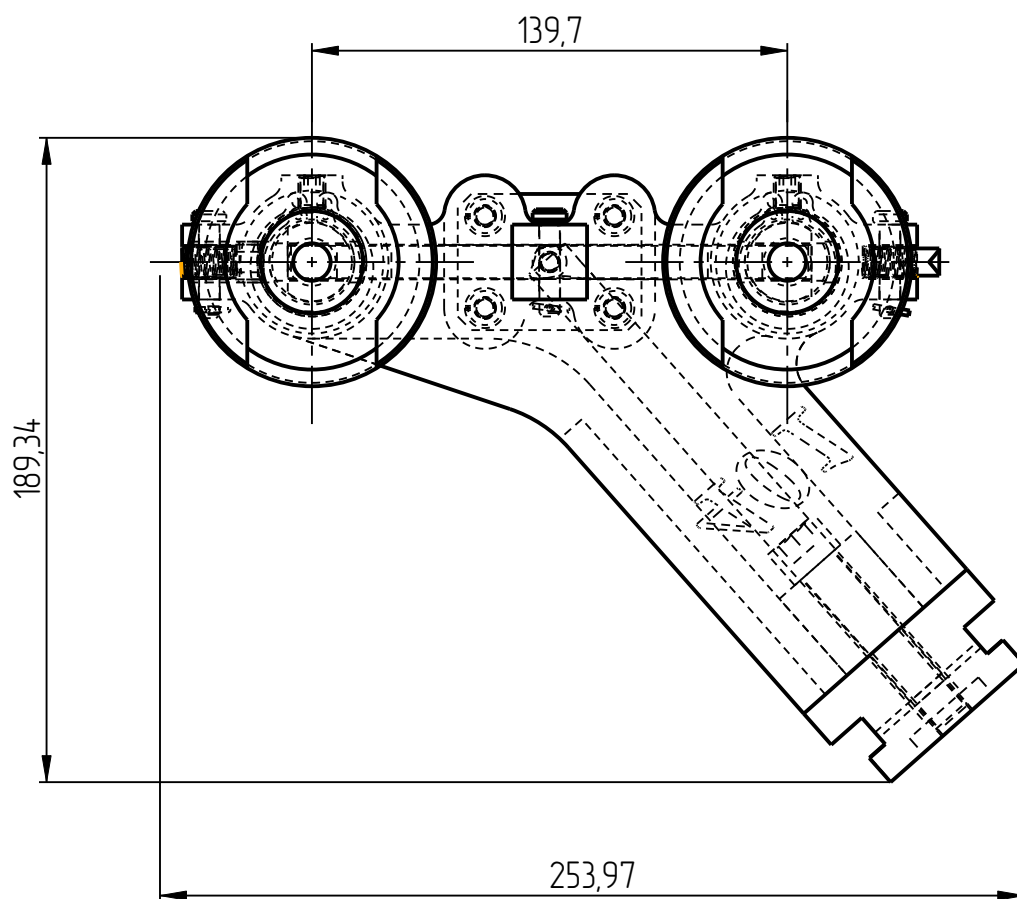

## Baffle holder DPG-401-004 Specification

№ pos.	Code	Name	Qty
<b>Parts</b>			
1	DPG-401-004-001	Main body	1
2	DPG-401-004-002	Baffle lock ring	2
3	DPG-401-004-003	Bushing	2
4	DPG-401-004-004	Lock	2
5	DPG-401-004-005	Equalizer	1
6	DPG-401-004-007	Spring	2
7	DPG-401-004-010	Pin	3
8	DPG-401-004-011	Plate	1
9	DPG-401-004-012	Holding plate	1
10	DPG-401-004-446	Leaf spring	1
<b>Standard parts</b>			
11	Spring washer B6-A4 DIN 127		4
12	Split pin 2x10 DIN 94		3
13	Retaining ring A25 DIN 471		2
14	Screw M6x10 DIN 912		1
15	Hex socket set screw M12x80 DIN 913		1
16	Screw M6x25 DIN 912		4
17	Screw M12x60 DIN 912		1
18	Hex socket set screw M8x10 DIN 913		2
19	Retaining ring A32 DIN 471		2

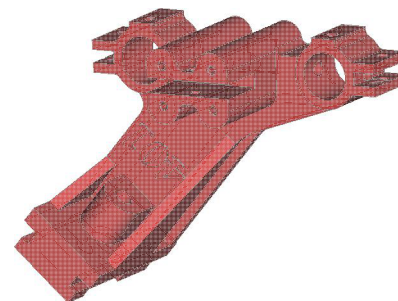
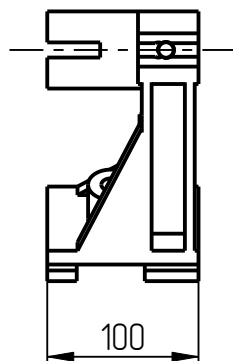
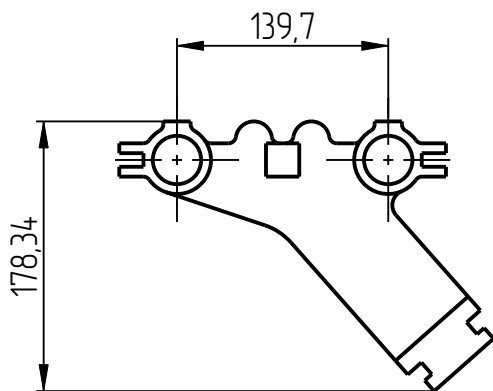

1. Main body  
DPG-401-004-001

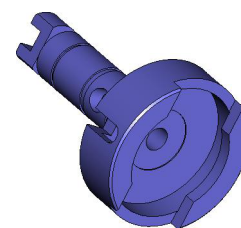
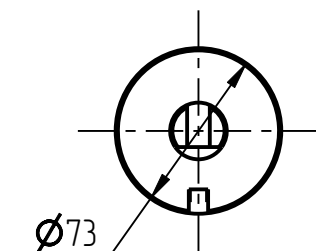
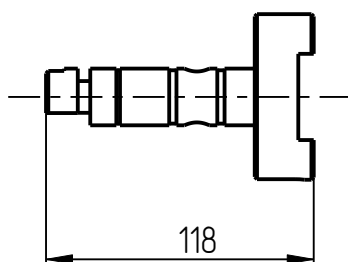

2. Baffle lock ring  
DPG-401-004-002

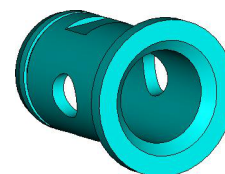
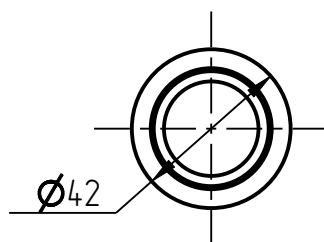
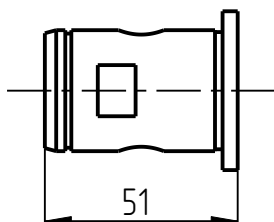

3. Bushing  
DPG-401-004-003

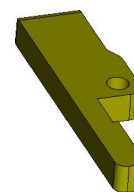
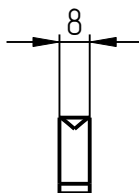
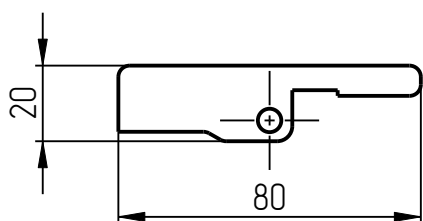

4. Lock  
DPG-401-004-004

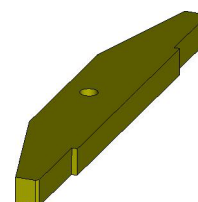
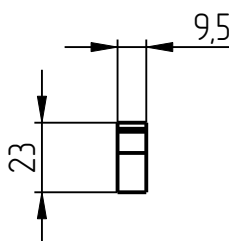
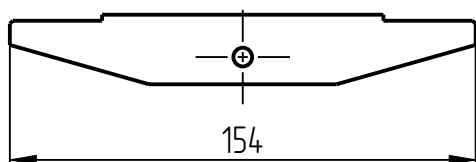

5. Equalizer  
DPG-401-004-005

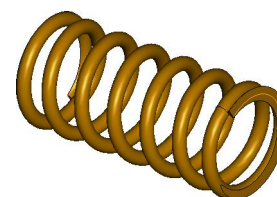
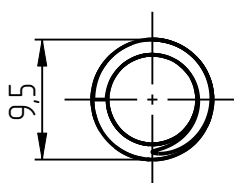
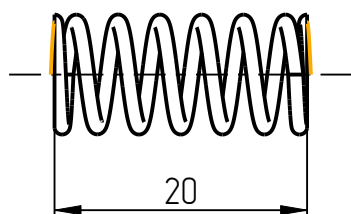

6. Spring  
DPG-401-004-007

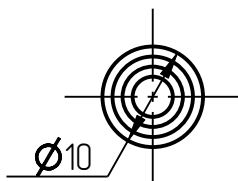
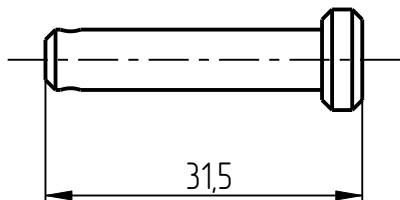

7. Pin  
DPG-401-004-010

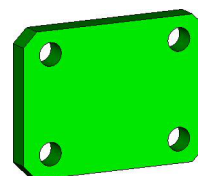
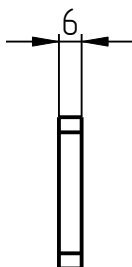
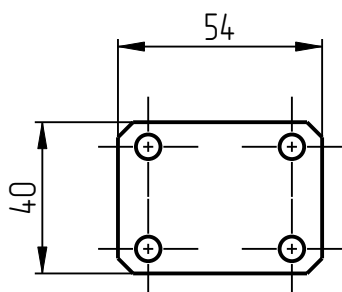

8. Plate  
DPG-401-004-011

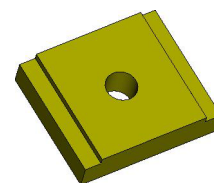
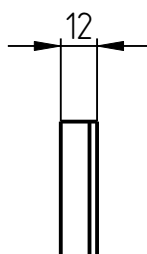
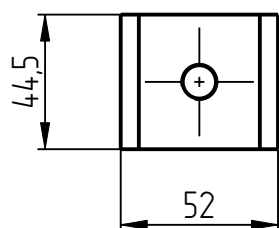

9. Holding plate  
DPG-401-004-012

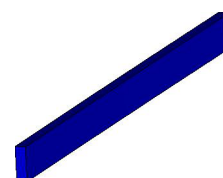
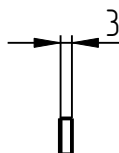
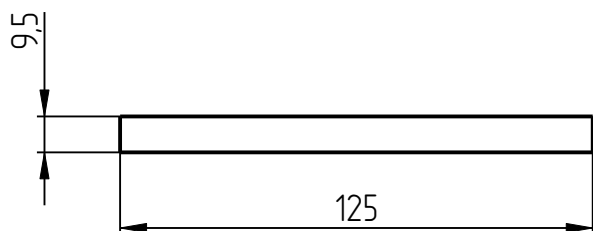

10. Leaf spring  
DPG-401-004-446